

# pst-optic

## Lenses and Mirrors; v.1.05

Manuel Luque

Herbert Voß

October 28, 2024

### Contents

<b>1</b>	<b>General Options</b>	<b>4</b>
1.1	<code>\resetOpticOptions</code> . . . . .	5
1.2	Optical axis line style . . . . .	5
<b>2</b>	<b>Lenses</b>	<b>6</b>
2.1	Short forms . . . . .	6
2.2	The Coordinates of the predefined Nodes . . . . .	6
2.3	The Lens Type . . . . .	8
2.4	<code>\Transform</code> . . . . .	10
2.5	<code>\rayInterLens</code> . . . . .	12
2.6	<code>\telescope</code> . . . . .	12
<b>3</b>	<b>Mirrors</b>	<b>13</b>
3.1	options . . . . .	13
3.2	<code>\mirrorCVG</code> . . . . .	14
<b>4</b>	<b><code>\mirrorDVG</code></b>	<b>16</b>
4.1	Drawing Rays in the Mirror Macros . . . . .	17
4.2	<code>\planMirrorRay</code> . . . . .	17
4.3	<code>\symPlan</code> . . . . .	17
4.4	Beam Light . . . . .	19
<b>5</b>	<b>Refraction</b>	<b>20</b>
<b>6</b>	<b><code>\refractionRay</code></b>	<b>20</b>
6.1	Total Reflection . . . . .	21
<b>7</b>	<b>Prism</b>	<b>21</b>
7.1	Figure with default values and construction indications . . . . .	22
7.2	Figure with default values, without construction indications . . . . .	22
7.3	Color matches wavelength . . . . .	23
<b>8</b>	<b>Spherical Optic</b>	<b>25</b>
8.1	<code>\lensSPH</code> . . . . .	25
8.2	Options . . . . .	26

---

<b>9</b>	<b>\mirrorCVG</b>	<b>27</b>
<b>10</b>	<b>\mirrorDVG</b>	<b>27</b>
<b>11</b>	<b>\ABinterSPHLens</b>	<b>27</b>
<b>12</b>	<b>\lensSPHRay</b>	<b>28</b>
<b>13</b>	<b>\reflectionRay</b>	<b>31</b>
	13.1 Refraction at a Spherical surface . . . . .	32
<b>14</b>	<b>Utility Macros</b>	<b>33</b>
	14.1 \eye . . . . .	33
<b>15</b>	<b>\Arrows</b>	<b>33</b>
<b>16</b>	<b>\psOutLine and \psBeforeLine</b>	<b>34</b>
<b>17</b>	<b>\Parallel</b>	<b>34</b>
<b>18</b>	<b>\ABinterCD and \nodeBetween</b>	<b>35</b>
<b>19</b>	<b>\rotateNode</b>	<b>36</b>
<b>20</b>	<b>\rotateTriangle</b>	<b>36</b>
<b>21</b>	<b>\rotateFrame</b>	<b>37</b>
<b>22</b>	<b>\arrowLine</b>	<b>37</b>
	22.1 Options . . . . .	38
<b>23</b>	<b>List of all optional arguments for pst-optic</b>	<b>39</b>
	<b>References</b>	<b>40</b>

`pst-optic` loads by default the following packages: `pstricks`, `pst-node`, `pst-plot`, `pst-3d`, `pst-grad`, `pst-math`, `multido`, and `pst-xke`. All should be already part of your local  $\text{T}_\text{E}\text{X}$  installation. If not, or in case of having older versions, go to <http://www.CTAN.org/> and load the newest version.

Thanks to:

Jean-Côme Charpentier, Arnaud Schmittbuhl, Keno Wehr

## 1 General Options

All options are by default document wide valid but not supported by all macros. Table 1 shows the general ones. Others are shown in Table 2 and 4.

**Table 1:** General options and the defaults

<i>Option</i>	<i>Name</i>	<i>Default</i>
Left value of the picture in cm	xLeft	-7.5
Right value of the picture in cm	xRight	7.5
Lowest value of the picture in cm	xBottom	-3
Highest value of the picture in cm	xTop	3
x-Offset	X0	0
y-Offset	Y0	0
Node A as string	nameA	A
Angle A in degrees	spotA	270
Node B as string	nameB	B
Angle B in degrees	spotB	90
Node F as string	nameF	F
Angle F in degrees	spotF	270
Node O as string	nameO	O
Angle O in degrees	spotO	225
Node A' as string	nameAi	A'
Angle A' in degrees	spotAi	90
Node B' as string	nameBi	B'
Angle B' in degrees	spotBi	270
Node F' as string	nameFi	B'
Angle F' in degrees	spotFi	270
Ray color	rayColor	black

`\pst-optic` puts the lens and mirror macros in an own `pspicture` environment. The star version enables the clipping option of `pstricks`:

```
\begin{pspicture}*(xLeft,yBottom)(xRight,yTop)
  \lens[focus=2,OA=-3,AB=1,X0=0,Y0=0,xLeft=-7.5,xRight=7.5,yBottom=-3,yTop=3]
\end{pspicture}
```

If you need other values for the `pspicture` environment, then use the `\rput` command to place the macro at any position.

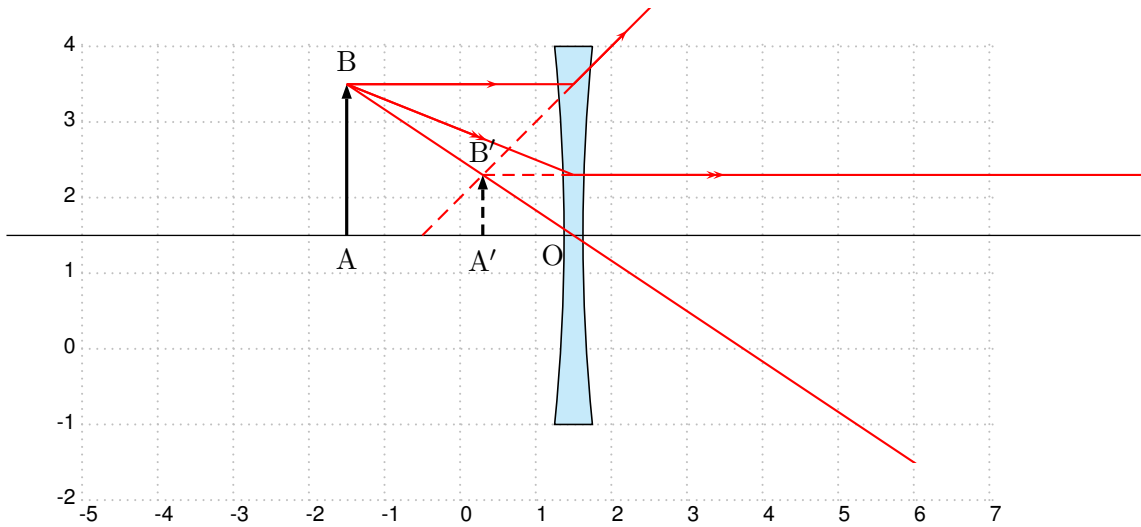

```
\begin{pspicture}[showgrid=true](-5,-2.2)(7,4)
\rput(1.5,1.5){%
  \lens[lensType=DVG,lensGlass,lensWidth=0.5,rayColor=red,
        focus=-2,AB=2,spotAi=270,spotBi=90]}
\end{pspicture}
```

### 1.1 \resetOpticOptions

The Macro `\resetOpticOptions` resets all `pst-optic` options to the default value.

### 1.2 Optical axis line style

`pst-optic` defines a line style `opticalAxis` with the predefined values of:

```
\newsstyle{opticalAxis}{linewidth=0.5pt,linecolor=black,linestyle=solid}
```

It can be overwritten in the same way with `\newsstyle`.

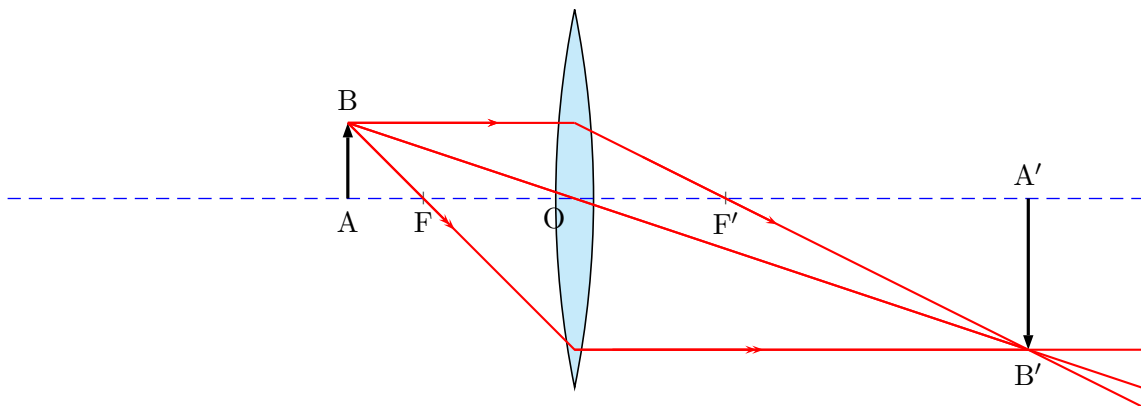

```
\newsstyle{opticalAxis}{linewidth=0.5pt,linecolor=blue,linestyle=dashed}
\lens
```

## 2 Lenses

There are macros for the convergent and divergent lens

```
\lens [Options]
\lensCVG % Convergent (Collecting lens) – default
\lensDVG % Divergent (Scatter lens)
\pslensCVG [Options] {lens width}{lens height}
\pslensDVG [Options] {lens width}{lens height}
```

The predefined options for `\lens` are `xLeft=-7.5`, `xRight=7.5`, `yBottom=-3`, `yTop=3`. The default color for the rays is red, which can be changed with the key `raycolor`. An individual color setting is possible for the focal, center, and parallel ray with the keywords: `parallelrayColor`, `focalrayColor`, and `centerrayColor`

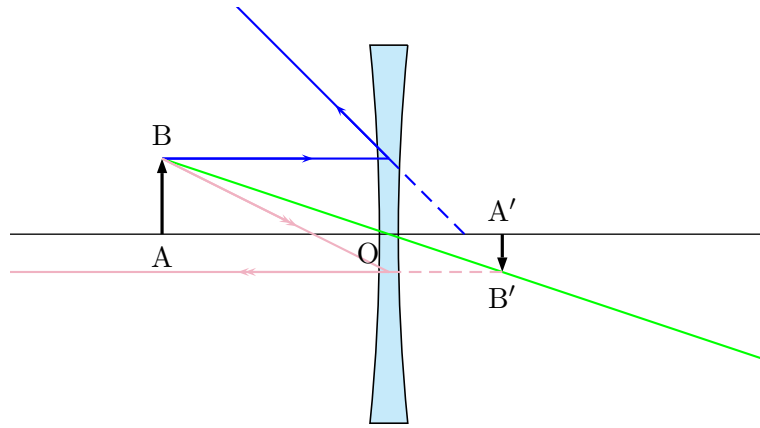

```
\begin{pspicture*}(-5,-3)(5,3)
\rput(0,0){\lens[lensType=DVG, parallelrayColor=blue, focalrayColor=red!80!blue!30,
centerrayColor=green, lensScale=1, focus=1, OA=-3, lensGlass, lensWidth=0.5]}
\end{pspicture*}
```

### 2.1 Short forms

The two macros `\lensCVG` and `\lensDVG` draw some more rays as the main macro `\lens` with the setting `lensType=CVG|DVG`. The only valid arguments are `lensScale`, `lensWidth`, and `lensHeight`, which must be set by `\psset`.

The two macros `\pslensCVG` and `\pslensDVG` have two mandatory arguments: `lens width` and `lens height`.

### 2.2 The Coordinates of the predefined Nodes

The following figure shows the coordinates of the predefined nodes (see Table 1).

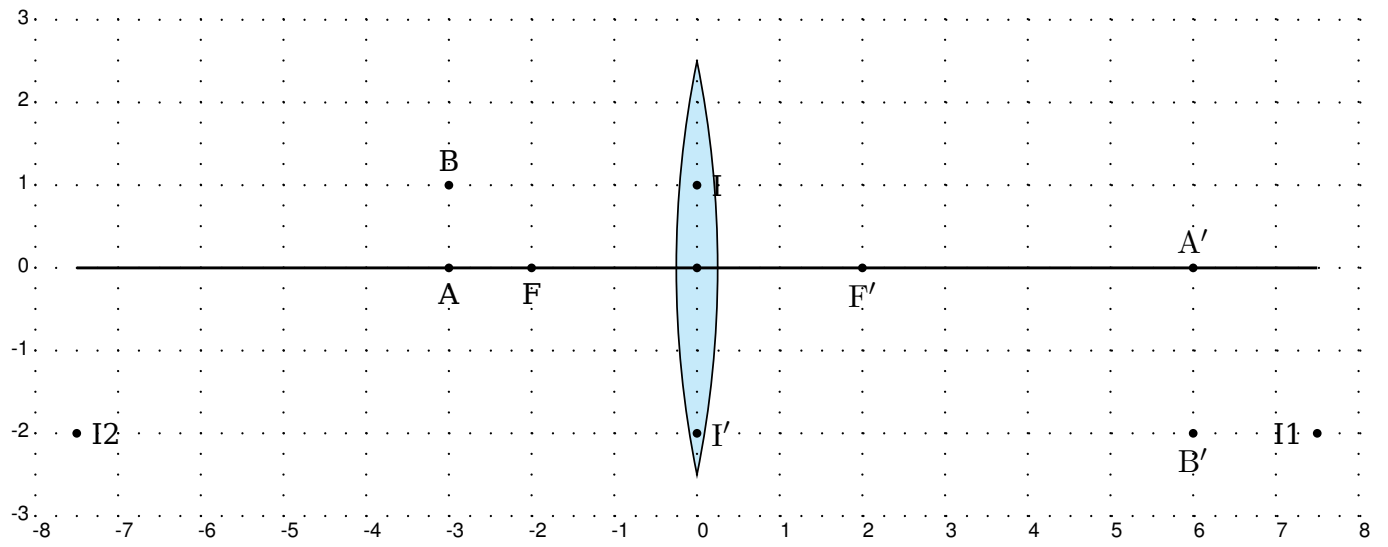

**Figure 1:** Coordinates of the predefined Nodes

2.3 The Lens Type

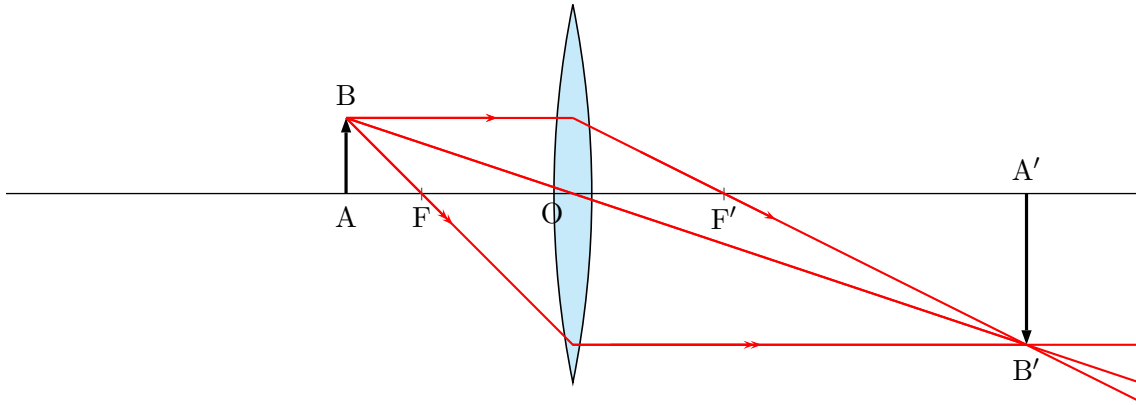

`\lens[lensType=CVG]`

Figure 2: Collecting lens

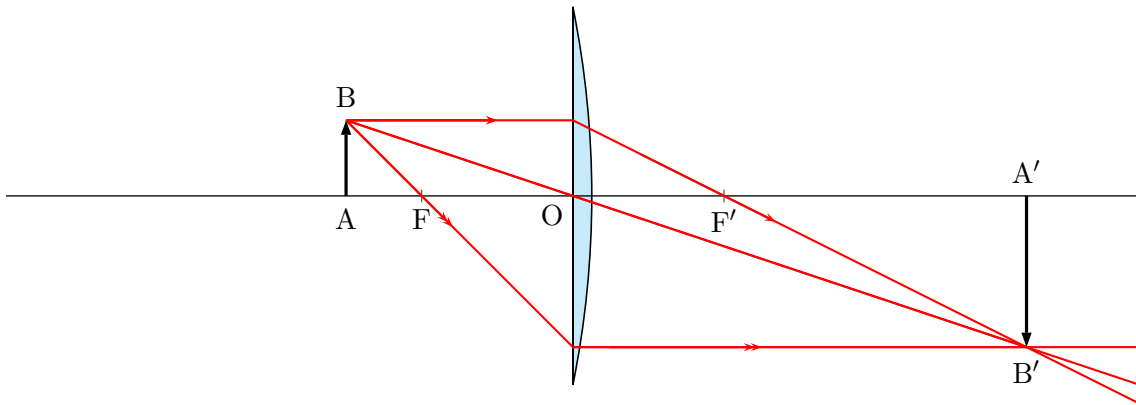

`\lens[lensType=PCVG]`

Figure 3: Plan Collecting lens

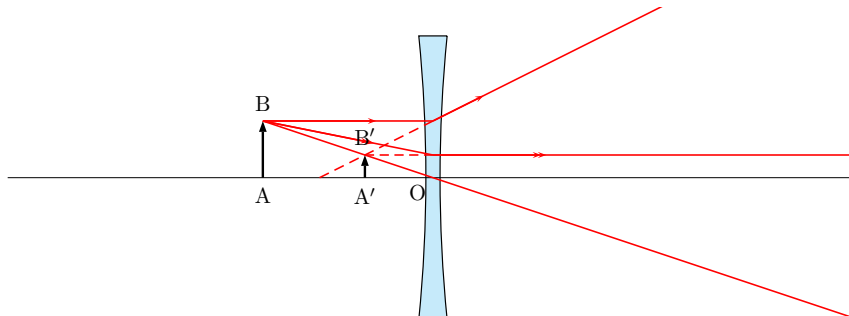

`\psscalebox{0.75}{\lens[lensType=DVG, focus=-2, spotAi=270, spotBi=90]}`

Figure 4: Scatter lens



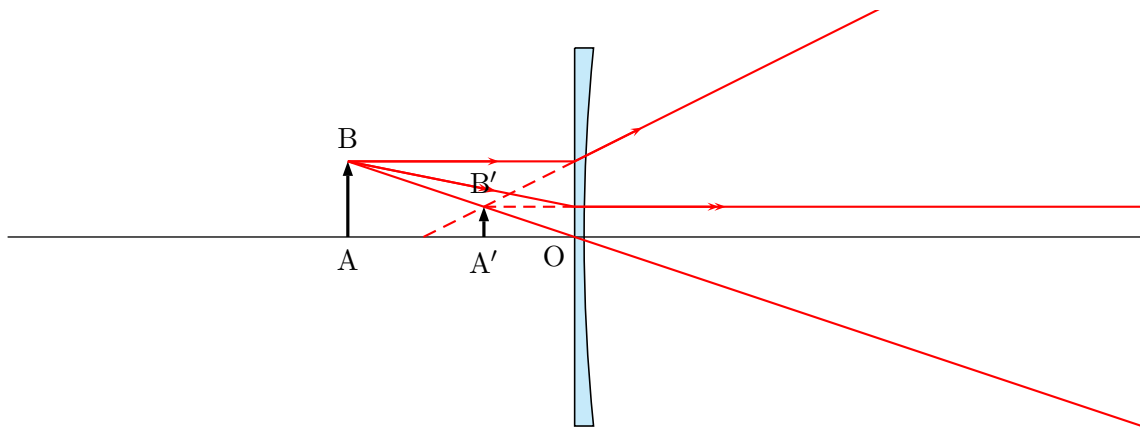

```
\lens[lensType=PDVG,focus=-2,spotAi=270,spotBi=90]
```

**Figure 5:** Plan Scatter lens

Using `\lens [lensType=...]` gives the in figures 2 and 4 shown lenses with the default values from Table 2.

**Table 2:** Available options for lenses with the defaults

<i>Option</i>	<i>Name</i>	<i>Default</i>
Lense type (CVG DVG PCVG PDVG)	lensType	CVG
Lense height in cm	lensHeight	5cm
Lense width in cm	lensWidth	0.5cm <sup>1</sup>
vertical scale (obsolet)	lensScale	1
View the lens	lensGlass	true
show only the rays	onlyrays	false
Second lens	lensTwo	false
Focus in cm	focus	2
Distance $\overline{OA}$	OA	-3
Distance $\overline{AB}$	AB	1
Lens color	lenscolor <sup>2</sup>	
Arrow length in cm	lensArrowSize <sup>2</sup>	0.2
Arrow inset in cm	lensArrowInset <sup>2</sup>	0.5

<sup>1</sup> only for lensGlass=true , otherwise set to 2\pslinewidth

<sup>2</sup> only for lensGlass=false

The origin of the coordinate system is by default vertically and horizontally symmetric. If you want to place the lens at another coordinates then define your own pspicture-environment and use the `\rput`-command:

```
\begin{pspicture}(-7.5,-3)(7.5,3)
  \rput(x,y){\lens[...]}
\begin{pspicture}
\begin{pspicture*}(-7.5,-3)(7.5,3)
  \rput(x,y){\lens[...]}
\begin{pspicture*}
```

The star version enables the clipping option.

2.4 \Transform

The \Transform-macro renames all existing nodes in names with an additional „1“. Table 3 shows a list of all nodes. \Transform also defines a new node factice with the coordinates (X01,Y01). The renaming of all nodes makes it easier to handle objects with more than one lens. With the option lensTwo=true it is possible to chain the different rays of the lenses (Figure 8).

Table 3: Renaming of the nodes after calling the macro \Transform

<i>old</i>	A	B	A'	B'	O	F	F'	I	I'	X0	Y0	OA'	A'B'
<i>new</i>	A1	B1	A'1	B'1	O1	F1	F'1	I1	I'1	X01	Y01	O1A'1	A'1B'1

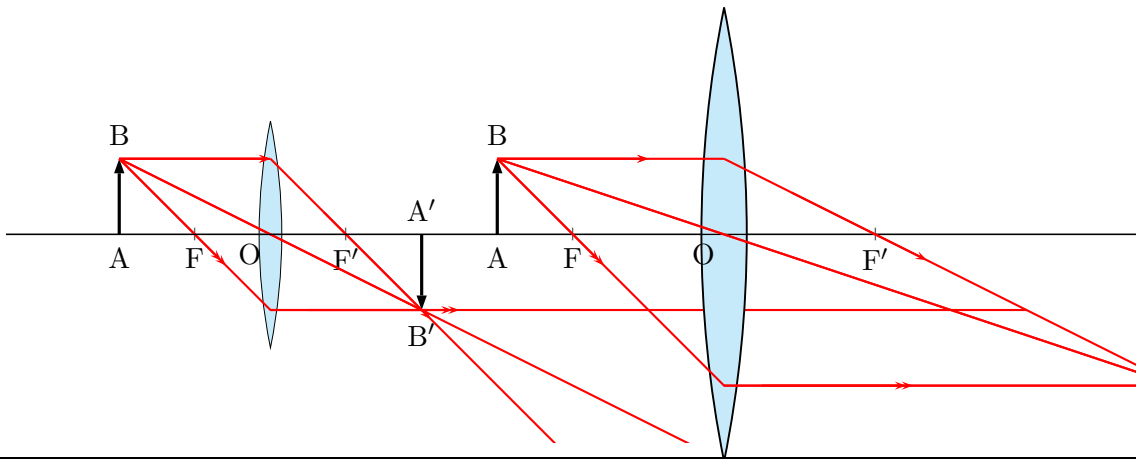

```
\begin{pspicture*}(-7.5,-2.75)(7.5,3)
\rput(0,0){\lens[lensScale=0.6,X0=-4,focus=1,OA=-2,lensGlass,lensWidth=0.5]}
\lens[lensScale=1.2,X0=2,focus=2,lensGlass,lensWidth=0.5]}
\end{pspicture*}
```

Figure 6: Definition of two unchained lenses

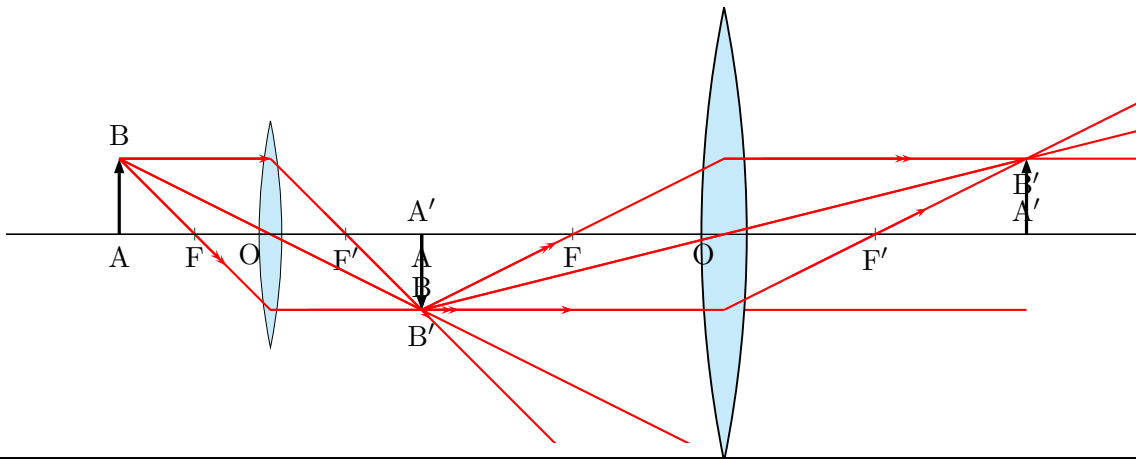

```
\begin{pspicture*}(-7.5,-2.75)(7.5,3)
\lens[lensScale=0.6,X0=-4,focus=1,OA=-2,lensGlass,lensWidth=0.5]}
\Transform
\lens[lensScale=1.2,X0=2,focus=2,lensTwo=true,lensGlass,lensWidth=0.5]}
\end{pspicture*}
```

Figure 7: Definition of two chained lenses

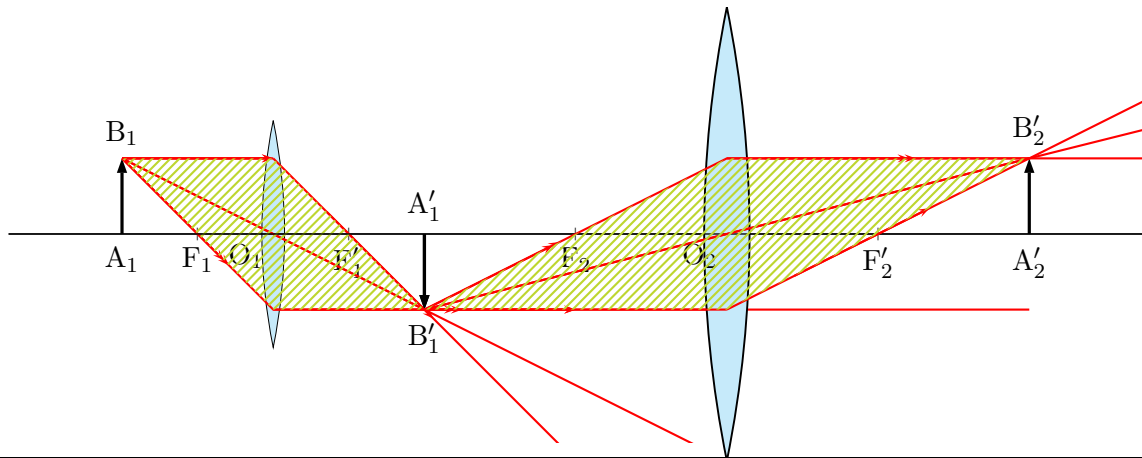

```

\begin{pspicture*}(-7.5,-2.75)(7.5,3)
\rput(0,0){\lens[lensScale=0.6,X0=-4,nameF=F_1,nameA=A_1,nameB=B_1,
nameFi=F'_1,nameAi={},nameBi={},nameO=O_1,focus=1,OA=-2,lensGlass,lensWidth=0.5]}
\pspolygon[style=rayuresJaunes,linestyle=none](B)(I)(B')(I')(B)
\Transform
\rput(0,0){\lens[lensScale=1.2,X0=2,focus=2,nameA=A'_1,spotA=90,nameB=B'_1,spotB=270,
nameO=O_2,nameAi=A'_2,spotAi=270,nameBi=B'_2,spotBi=90,nameF=F_2,nameFi=F'_2,
lensTwo=true,lensGlass,lensWidth=0.5]}
\pspolygon[style=rayuresJaunes,linestyle=none](B)(I)(B')(I')(B)
\end{pspicture*}

```

**Figure 8:** Definition of two chained lenses and an additional modification of the node labels.

## 2.5 `\rayInterLens`

This macro is only useful for a two-lens-system. Figure 9 shows such a system. The nodes B1, I11, F'1, and B'1 are predefined by the `\lens`-macro. To draw the two rays from the left lens via the node B'1 to the second lens, we need the coordinates of these points. `\rayInterLens` defines such nodes. The Syntax:

```
\rayInterLens(StartNode)(IntermediatNode)(LensDistance){LensNode}
```

Two parallel lines are drawn with the `\Parallel`-Macro.

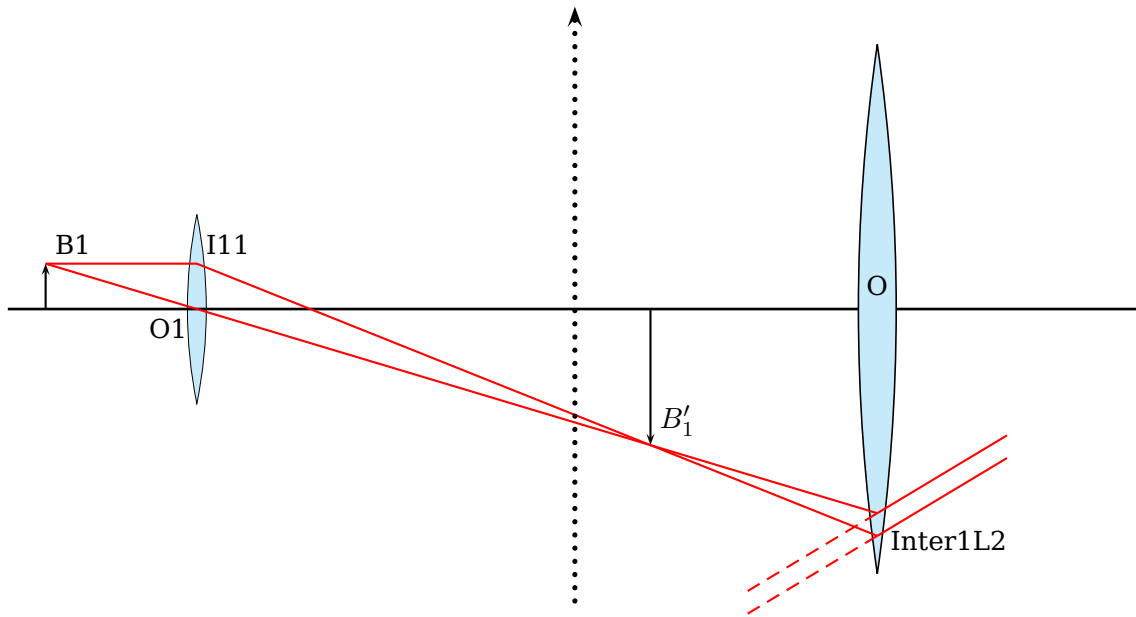

```
\begin{pspicture*}(-7.5,-4)(7.5,4)
\lens[focus=1.5,OA=-2,AB=0.6,X0=-5,lensGlass,yBottom=-4,yTop=4,drawing=false,
lensWidth=0.5,lensScale=0.5,nameF=F_1,nameFi=F'_1]}
\psline[linewidth=1pt](xLeft)(xRight)
\Transform
\lens[focus=2,X0=4,lensGlass,yBottom=-4,yTop=4,drawing=false,lensWidth=0.5,
lensHeight=7,nameF=F_2,nameFi=F'_2,spotF=90,spotFi=90]}
\psline{->}(A1)(B1)\psline{->}(A'1)(B'1)
\psset{linecolor=red}
\uput[45](B1){B1} \uput[90](0){0} \uput[225](O1){O1} \uput[45](I11){I11} \uput[45](B'1){$B'_1$}
\rayInterLens(I11)(B'1){4}{Inter1L2} \rayInterLens(O1)(B'1){4}{Inter2L2}
\uput[350](Inter1L2){Inter1L2}
\psline(B1)(I11)(B'1)(Inter1L2) \psline(B1)(O1)(B'1)(Inter2L2)
\Parallel(B'1)(0)(Inter2L2){B2inftyRigth} \Parallel(B'1)(0)(Inter1L2){B3inftyRigth}
\psset{length=-2,linestyle=dashed}
\Parallel(B'1)(0)(Inter2L2){B2inftyLeft} \Parallel(B'1)(0)(Inter1L2){B3inftyLeft}
\psline[linestyle=dotted,linewidth=2pt,linecolor=black]{->}(0,-4)(0,+4)
\end{pspicture*}
```

Figure 9: Demonstration of `\rayInterLens`

## 2.6 `\telescope`

Figure 10 shows the configuration of a telescope and Table 4 the special options for the `\telescope`-Macro.

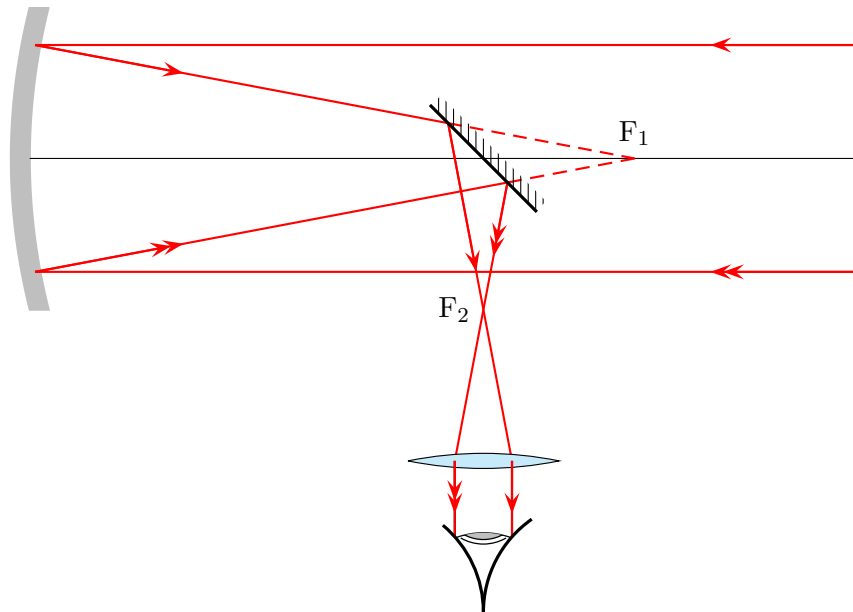

\telescope

**Figure 10:** \telescope-Macro

### 3 Mirrors

#### 3.1 options

Figure 11 shows the available mirrors and Table 4 the possible options.

**Table 4:** List of options for mirrors with the predefines values

<i>Option</i>	<i>Name</i>	<i>Default</i>
Left value of the picture in cm	xLeft	-0.5
Right value of the picture in cm	xRight	11
Lowest value of the picture in cm	xBottom	-6
Highest value of the picture in cm	xTop	2.5
Mirror height in cm	mirrorHeight	5
Mirror depth in cm	mirrorDepth	1
Mirror width in cm	mirrorWidth	0.25
Mirror color	mirrorColor	lightgray
Ray color	rayColor	black
Focus in cm (only together with the option posMirrorTwo senseful)	mirrorFocus	8
Position of the 2. mirror in cm	posMirrorTwo	8
Inclination of the 2. mirror in degrees	mirrorTwoAngle	45
Draw lines	drawing	true

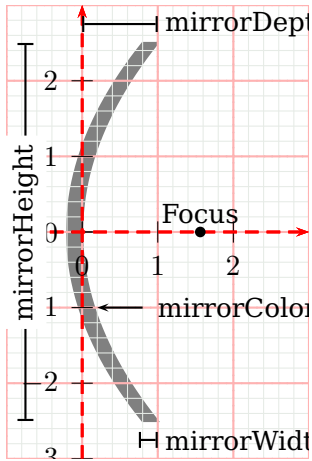

```
\begin{pspicture*}[showgrid=true](-1,-3)(3,3)
\rput(0,0){\mirrorCVG[mirrorColor=gray,drawing=false]}
\psaxes[linestyle=dashed,linecolor=red,linewidth=1pt,arrows=->](0,0)(-1,-3)
(3,3)
\qdisk(Focus){2pt} \rput(Focus){\rput(0,0.25){Focus}}
\pcline[arrows=| - |](-0.75,-2.5)(-0.75,2.5) \ncput*[nrot=:U]{mirrorHeight}
\pcline[arrows=| - |](0,2.75)(1,2.75) \rput[l](1.1,2.75){mirrorDepth}
\pcline[arrows=| - |](1,-2.75)(0.75,-2.75) \rput[l](1.1,-2.75){mirrorWidth}
\rput[l](1,-1){mirrorColor}
\psline{<-}(0.2,-1)(0.8,-1)
\end{pspicture*}
```

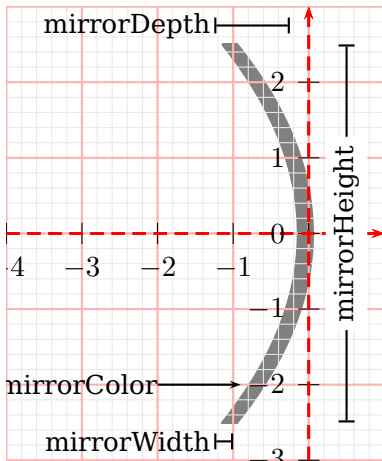

```
\begin{pspicture*}[showgrid=true](-4,-3)(1,3)
\rput(0,0){\mirrorDVG[mirrorColor=gray,drawing=false]}
\psaxes[linestyle=dashed,linecolor=red,linewidth=1pt,arrows=->](0,0)
(-4,-3)(1,3)
\qdisk(Focus){2pt} \rput(Focus){\rput(0,0.25){Focus}}
\pcline[arrows=| - |](.5,-2.5)(.5,2.5) \ncput*[nrot=:U]{mirrorHeight}
\pcline[arrows=| - |](-1.25,2.75)(-.25,2.75) \rput[r](-1.3,2.75){
mirrorDepth}
\pcline[arrows=| - |](-1.25,-2.75)(-1,-2.75) \rput[r](-1.3,-2.75){
mirrorWidth}
\rput[r](-2,-2){mirrorColor} \psline{->}(-2,-2)(-0.9,-2)
\end{pspicture*}
```

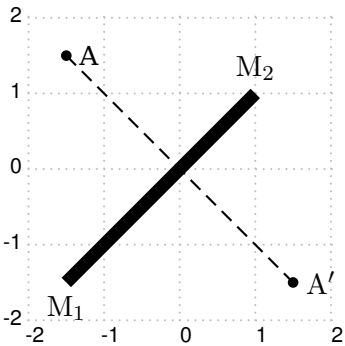

```
\begin{pspicture}[showgrid=true](-2,-2)(2,2)
\node(-1.5,-1.5){M1} \node(1,1){M2}
\uput[-90](M1){\mathrm{M_1}}\uput[90](M2){\mathrm{M_2}}
\node(-1.5,1.5){A}
\planMirrorRay(A)(M1)(M2){A'}
\psline[linewidth=5pt](M1)(M2)\pscircle*(A){2pt}
\uput[0](A){A} \uput[0](A'){\mathrm{A'}}
\pscircle*(A'){2pt} \psline[linestyle=dashed](A)(A')
\end{pspicture}
```

Figure 11: The different mirror macros: a) `\mirrorCVG` b) `\mirrorDVG` c) `\planMirrorRay`

### 3.2 `\mirrorCVG`

Figure 12 shows the default for the `\mirrorCVG`-macro with the predefined nodes and three default rays.

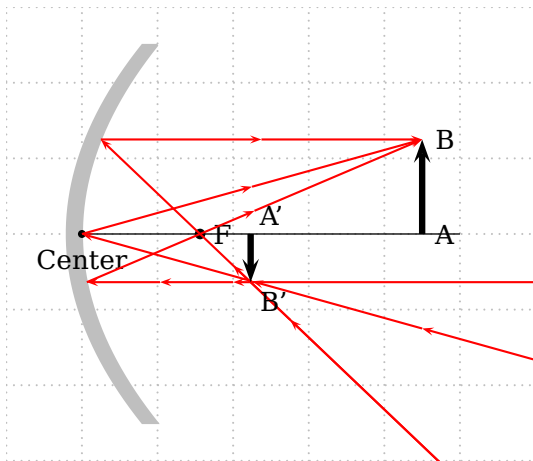

```
\begin{pspicture*}[showgrid=true](-1,-3)(6,3)
  \rput(0,0){\mirrorCVG[rayColor=red]}
\end{pspicture*}
```

**Figure 12:** Parabolic Mirror `\mirrorCVG`

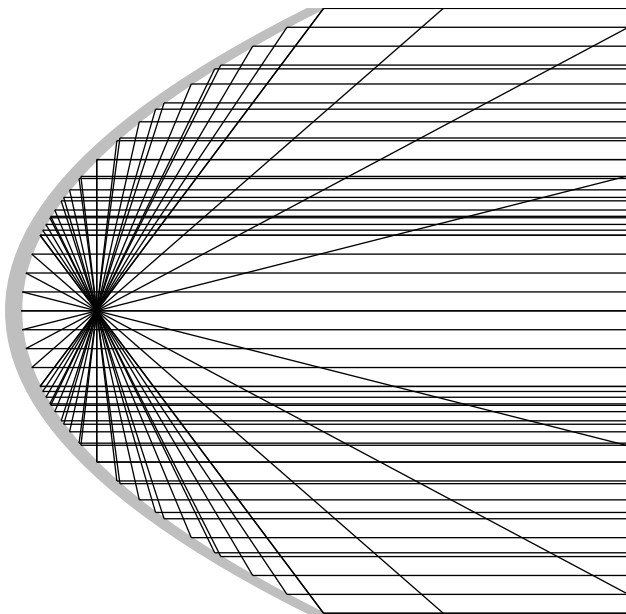

```
\begin{pspicture*}(-0.5,-4)(8,4)
  \rput(0,0){\mirrorCVG[mirrorHeight=8,mirrorDepth=4,drawing=false]}
  \multido{\rY=-4.00+0.25}{33}{%
    \mirrorCVGRay[lineWidth=0.5pt,mirrorHeight=8,mirrorDepth=4](10,\rY)(1,\rY){Dummy}}
\end{pspicture*}
```

**Figure 13:** Example

4 \mirrorDVG

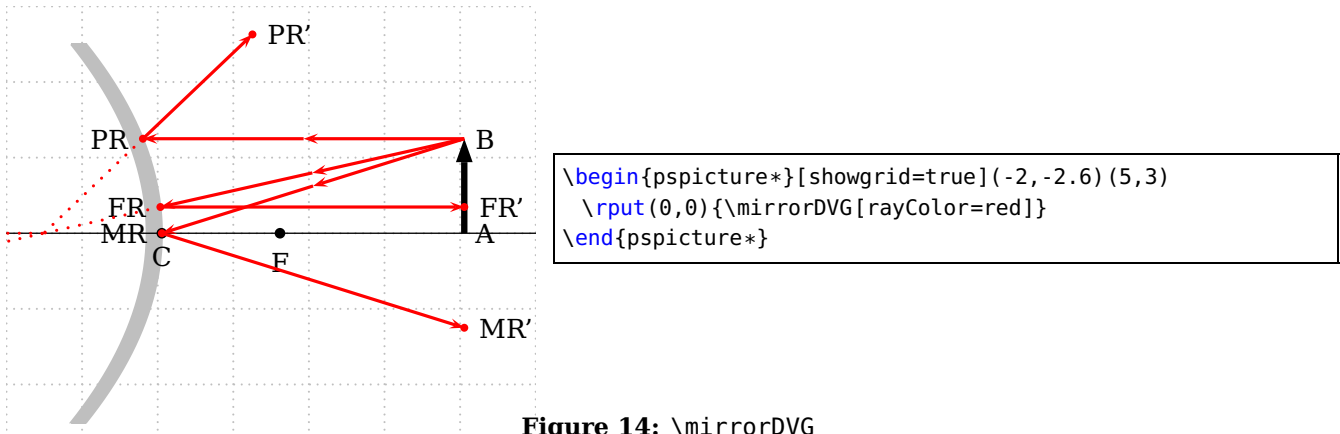
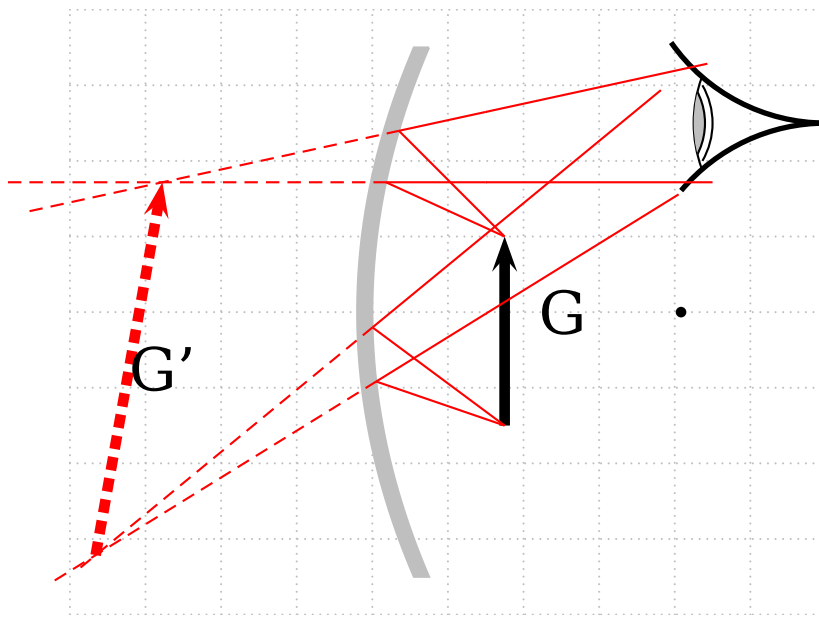

Figure 14: \mirrorDVG



```

\begin{pspicture*}[showgrid=true](-4,-4)(6,4)
  \mirrorCVG[drawing=false,mirrorDepth=0.75,mirrorHeight=7]}
  \rput(6,2.5){\eye}
  \pnode(1.75,1){B}\psline[arrows=->,linewidth=4pt](A)(B)
  \Huge G \psset{linecolor=red}
  \mirrorDVG[rayColor=red,mirrorHeight=7,mirrorDepth=0.75](A)(0,-0.9){P1}
  \psBeforeLine[length=5,linestyle=dashed](P1)(P1'){\PBegin}
  \mirrorDVG[rayColor=red,mirrorHeight=7,mirrorDepth=0.75](A)(0,-0.2){P2}
  \psBeforeLine[length=5,linestyle=dashed](P2)(P2'){\PBegin}
  \mirrorDVG[rayColor=red,mirrorHeight=7,mirrorDepth=0.75](B)(0,2.75){P3}
  \psBeforeLine[length=5,linestyle=dashed](P3)(P3'){\PBegin}
  \mirrorDVG[rayColor=red,mirrorHeight=7,mirrorDepth=0.75](B)(0,1.8){P4}
  \psBeforeLine[length=5,linestyle=dashed](P4)(P4'){\PBegin}
  \ABinterCD(P1)(P1')(P2)(P2'){\B'}
  \psBeforeLine[linewidth=4pt,linestyle=dashed](B')(A')
  \uput{0}{0}{G'}\Huge G'
\end{pspicture*}

```

Figure 15: Example as a magnifier



## 4.1 Drawing Rays in the Mirror Macros

There are two different macros for drawing rays:

```
\mirrorCVGRay [Options] (Node1) (Node2) {MirrorNode}
\mirrorDVGRay [Options] (Node1) (Node2) (MirrorNode)
```

The MirrorNode maybe :

MirrorNode		first point on the mirror
MirrorNode'		end node or second point on the mirror if one more reflection happens
MirrorNode''		end node for a second reflection

If there are only one reflection, then MirrorNode' and MirrorNode'' are the same.

## 4.2 \planMirrorRay

The \planMirrorRay-Macro calculates the coordinates of a mirrored point. In Figure 11 is a given node A, whereas A' is calculated by the macro. The syntax is:

```
\planMirrorRay (Mirrorbegin) (Mirrorend) (Originalpoint) {New point}
```

The macro doesn't draw any lines, only the coordinates of the new point are saved by the new node name.

## 4.3 \symPlan

\symPlan allows to mirroring complete plain graphical objects along a virtual center line. Figure 16 shows that this mirroring is a mathematical one and not a physical one. The syntax is:

```
\symPlan (node1) (node2) {graphic object}
```

The two nodes define the mirror axis and the graphics object is in most cases a user defined macro, f.ex: This example needs the package pst-text for the \psttextpath macro.

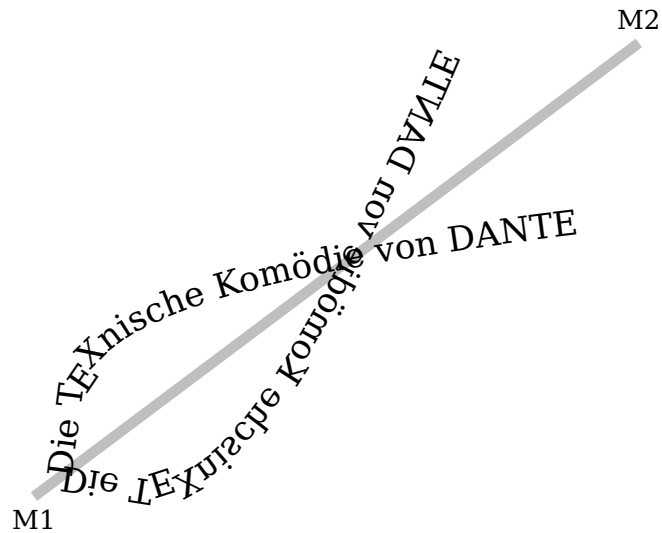

```

\newcommand{\dtk}{\pstextpath(0,0){%
  \psplot[linestyle=none]{0}{8}{x sqrt sqrt 2 mul}}%
  {\Large Die \TeX{nische Kom"odie von DANTE}}
\begin{pspicture}(-4.5,-2.5)(2.5,5)
\pnode(-4,-2){M1} \uput[-90](M1){M1}
\pnode(4,4){M2}\uput[90](M2){M2}
\psline[linewidth=5\pslinewidth,linicolor=lightgray](M1)(M2)
\rput(-3.5,-1.75){\dtk}
\symPlan(M1)(M2){\rput(-3.5,-1.75){\dtk}}
\end{pspicture}

```

**Figure 16:** Demonstration of the \symPlan-Macro

## 4.4 Beam Light

This macro is useful for the demonstration of high and low beam light. The syntax for this macro is:

```
\beamLight [Options]
```

The predefined options especially for the pspicture-coordinates are

```
\psset[pst-optic]{xLeft=-5,xRight=5,yBottom=-5,yTop=5,drawing=false}% the default
```

You can place this macro with the \rput-command at any place in your own pspicture-environment.

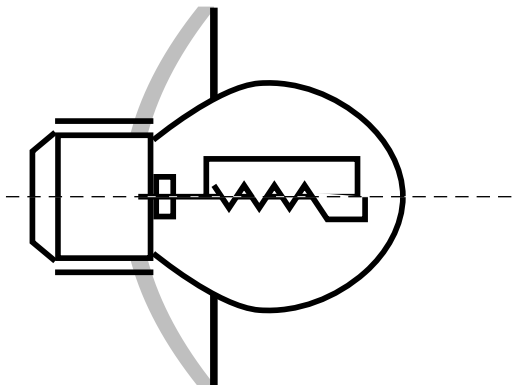

```
\begin{pspicture}(-1,-3)(3,3)
  \rput(0,0){\beamLight}
\end{pspicture}
```

**Figure 17:** \beamLight without any Options

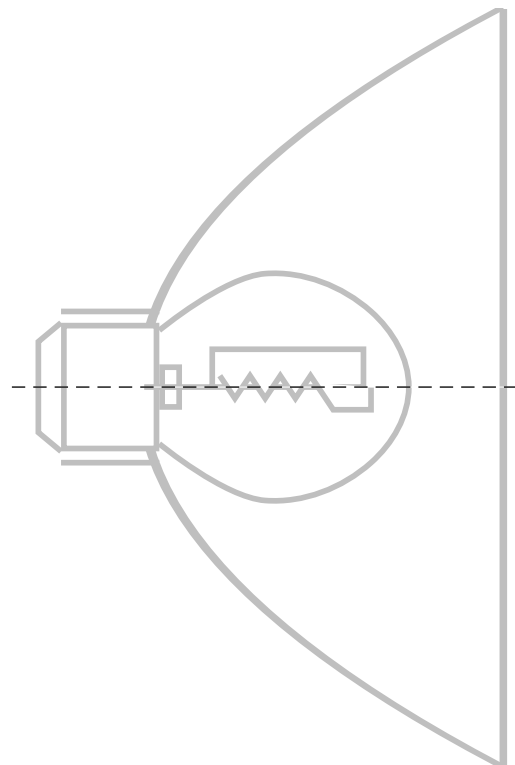

```
\begin{pspicture}(-1,-5.5)(5,5.5)
  \rput(0,0){\beamLight[mirrorDepth=4.75,
    mirrorWidth=0.1,mirrorHeight=10,
    linecolor=lightgray]}
\end{pspicture}
```

**Figure 18:** \beamLight with Options

## 5 Refraction

### 6 \refractionRay

The syntax is

```
\refractionRay(A)(B)(C)(D){n1}{n2}{EndNode}
```

The macro uses the law of Snell

$$\frac{n_1}{n_2} = \frac{\sin \beta}{\sin \alpha} \quad (1)$$

where the  $n_1$  and  $n_2$  are the refraction numbers and  $\alpha$  the incoming and  $\beta$  the outgoing angle of the ray.

A total reflection instead of a normal refraction is possible, when the ray starts in a medium with a higher refraction number. This happens when  $\sin \beta > 1$  in Equ. 1. In this case we have  $\alpha = \beta$ , a total reflection.

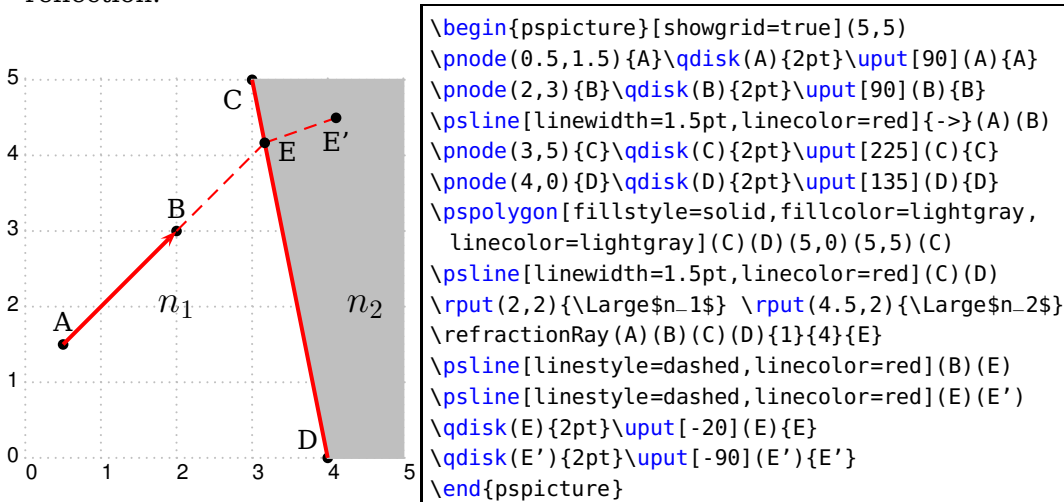

The macro needs the values for the four nodes, the two refraction numbers and the name for the end node which is on the intermediate line of  $n_1$  and  $n_2$ . As you can see in the figure the end node of the ray is the intermediate point between the linear ray and the linear medium. The end node of the refracted ray has the same name with an additional single quotation mark. In the figure the macro was called as

```
\refractionRay(A)(B)(C)(D){1}{4}{E}
```

with

$$n_1 < n_2 \quad (2)$$

and with the endnode defined as  $E'$  (internally defined). You can get longer lines with the optional argument `nodesep` and negatives values:

```
\pcline[arrowscale=2,linewidth=1pt,linecolor=red,
nodesepB=-2cm]{->}(E)(E')
```

It is no problem to draw a ray which is going straight through another medium. It can be done by using the macro twice as shown in the following examples.

## 6.1 Total Reflection

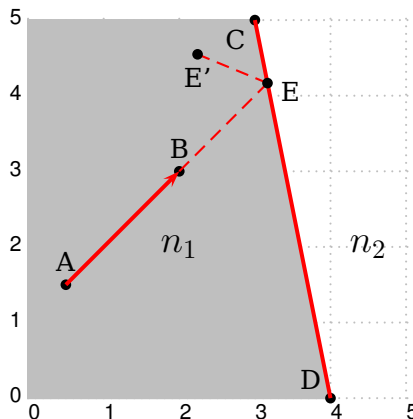

```

\begin{pspicture}[showgrid=true](5,5)
\pnode(0.5,1.5){A}\pnode(2,3){B}
\pnode(3,5){C}\pnode(4,0){D}
\pspolygon[fillstyle=solid,fillcolor=lightgray,
linecolor=lightgray](C)(D)(0,0)(0,5)(C)
\qdisk(A){2pt}\uput[90](A){A}
\qdisk(B){2pt}\uput[90](B){B}
\qdisk(C){2pt}\uput[225](C){C}
\qdisk(D){2pt}\uput[135](D){D}
\psline[linewidth=1.5pt,linecolor=red]{->}(A)(B)
\psline[linewidth=1.5pt,linecolor=red](C)(D)
\rput(2,2){\Large$n_1$}\rput(4.5,2){\Large$n_2$}
\refractionRay(A)(B)(C)(D){4}{1}{E}
\psline[linestyle=dashed,linecolor=red](B)(E)
\psline[linestyle=dashed,linecolor=red](E)(E')
\qdisk(E){2pt}\uput[-20](E){E}
\qdisk(E'){2pt}\uput[-90](E'){E'}
\end{pspicture}

```

In the figure the macro was called as

```
\refractionRay(A)(B)(C)(D){4}{1}{E}
```

$$n_1 > n_2 \quad (3)$$

## 7 Prism

This command allows to simulate the deviation of a mono-chromatic light ray with a prism. There are only few parameters. The indicated values are the default ones.

<i>name</i>	<i>meaning</i>	<i>default</i>
AnglePrism	The angle to the top of prism.	60
AnglePlan1	The angle between the plane (1), where the transmitter takes place, and the vertical. Negative values are allowed.	25
AnglePlan2	The angle between the plane (2) (the screen), and the vertical. Negative values are allowed.	55
k	Position of transmitter relative to choosen origin $C_1$ on the plane : $\overrightarrow{C_1 E_1} = k \vec{u}_1$ .	1
lambda	The wavelength , in nm.	632.8
notations	The plane where transmitting source takes place, with all indications, origin, angle, etc., as well as the screen are displayed by default. This can be useful in order to finalize a figure, but it is possible to deactivate this feature with the option.	false

With AnglePlan1 the incident ray direction can be changed. The incidence spot changes according to k.

The outline of processing we have adopted is the Gernot Hoffmann one. For more details look into the document: <http://www.fho-empden.de/~hoffmann/prism16072005.pdf>

### 7.1 Figure with default values and construction indications

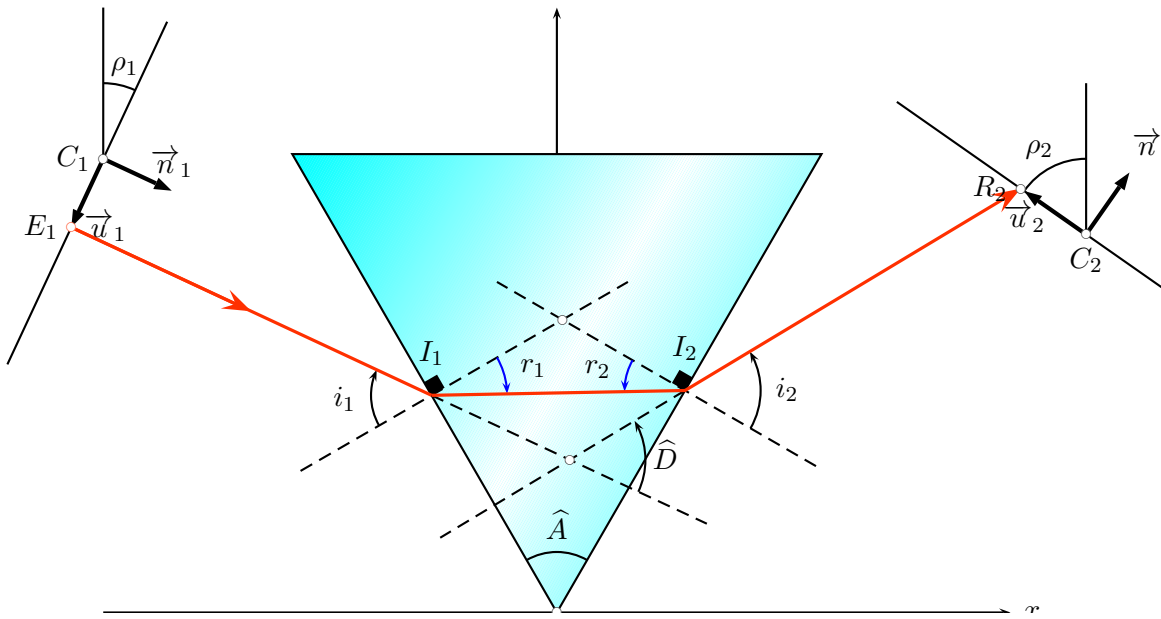

```
\begin{pspicture*}(-8,0)(8,8)
\psprism
\end{pspicture*}
```

### 7.2 Figure with default values, without construction indications

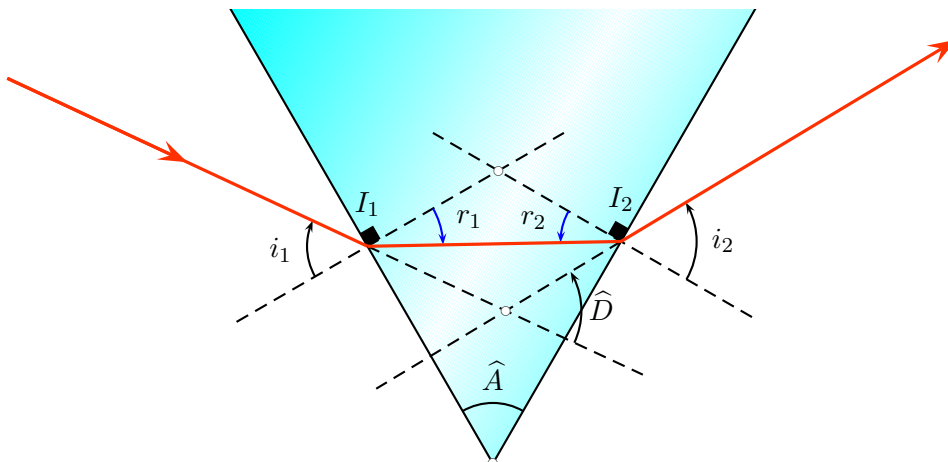

```
\begin{pspicture*}(-8,0)(8,6)
\psprism[notations=false]
\end{pspicture*}
```

7.3 Color matches wavelength

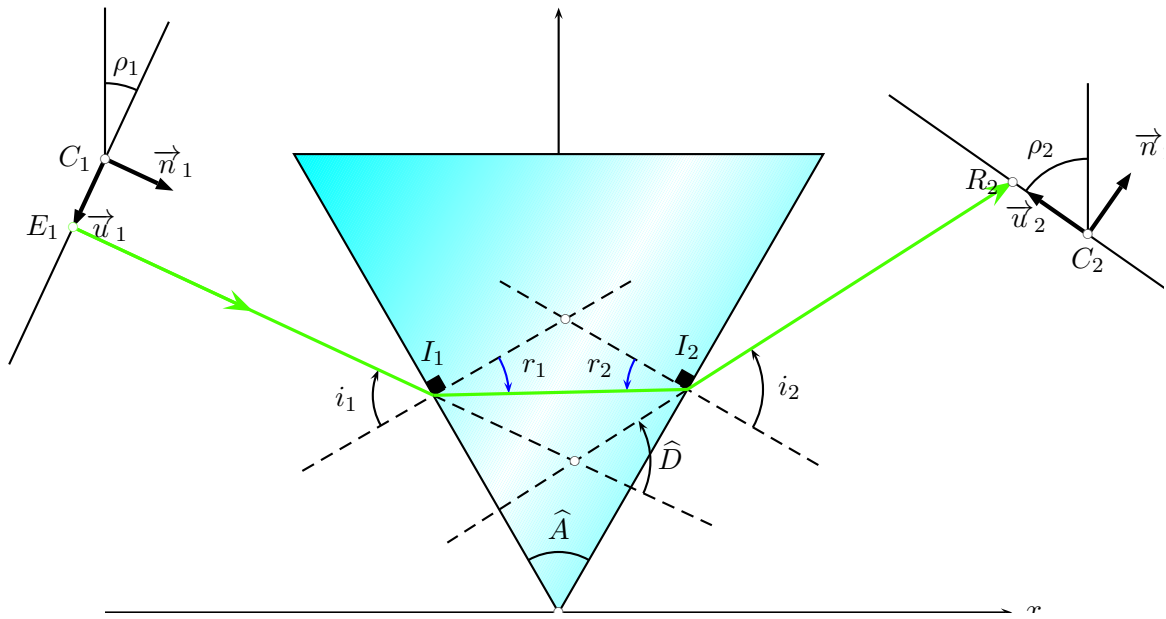

```
\begin{pspicture*}(-8,0)(8,8)
\psprism[lambda=530]%
\end{pspicture*}
```

Note: we have not planned physical impossibilities. When  $r_2$  is greater than the limit angle, there is no transmission in air, and it's impossible to calculate  $i_2$ . Then, we have a PostScript message:

```
Displaying page 1
Displaying page 2
Displaying page 3
Displaying page 4
Error: /rangecheck in --sqrt--
Operand stack:
alpha2 -1.02701 -0.0547467
```

We remind you that  $\alpha_2$  is  $i_2$ .  
 For instance, AnglePrism=65, other default parameters remains unchanged.

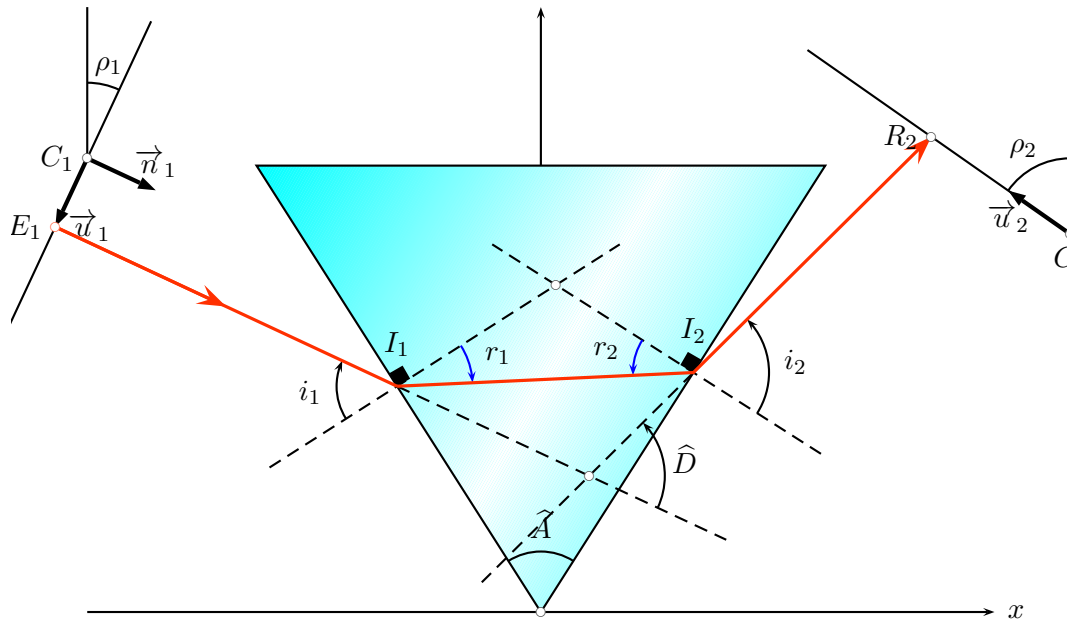

```
\begin{pspicture*}(-7,-0.2)(7,8)
\psprism[AnglePrism=65]
\end{pspicture*}
```

It will become right when we change the incident ray slope:

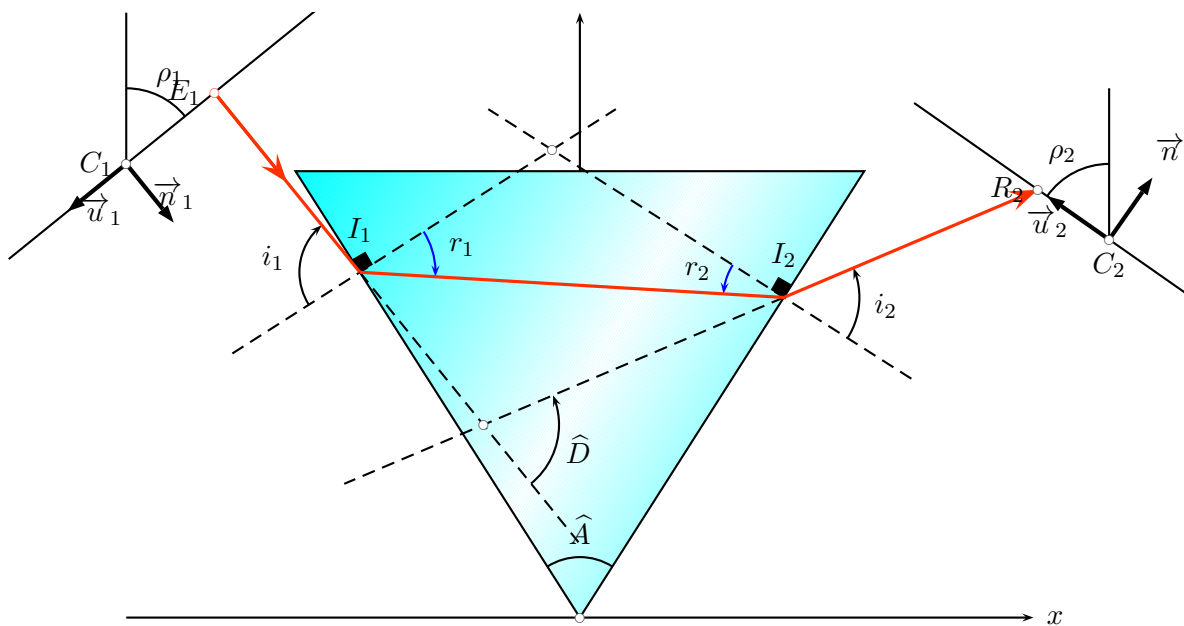

```
\begin{pspicture*}(-8,-0.2)(8,8)
\psprism[AnglePrism=65,AnglePlan1=51,k=-1.5]
\end{pspicture*}
```

We choose  $k=-1.5$  in order to have a incident ray which strikes (?) the input side roudly in its center. But, in these particular cases, the physicist know-how is important (*bis repetita*). Isn't it?



## 8 Spherical Optic

### 8.1 \lensSPH

The syntax is

```
\lensSPH [Options]
```

It changes some default values for the options to:

meaning	name	default
Object Distance in cm	OA	-7
Lens Height in cm	lensHeight	6
Lens Width in cm	lensWidth	1.5
Refraction Number $n_2$	refractB	2

#### Convergent Lens

Without any option it draws a spherical convergent lens. `\lensSPH` is equivalent to `\lensSPH[lensType=CVG]`.

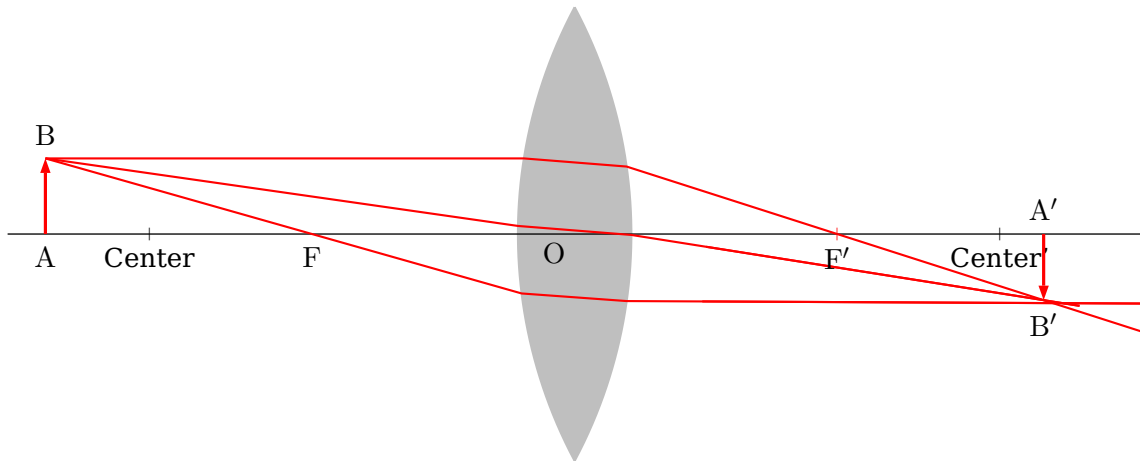

```
\lensSPH
```

#### Divergent Lens

The syntax is

```
\lensSPH [lensType=DVG , ...]
```

It draws a spherical divergent lens:

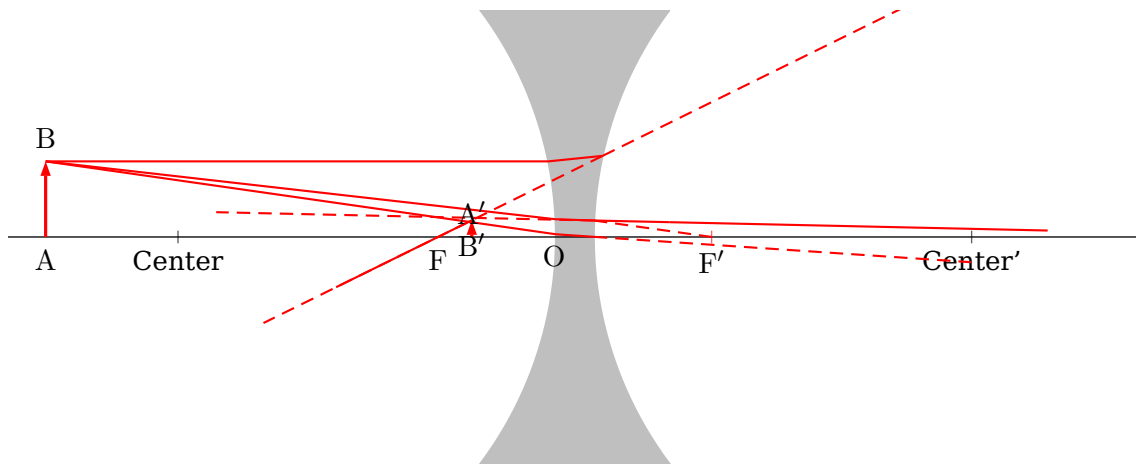

```
\lensSPH[lensType=DVG,lensWidth=0.5]
```

It changes some default values for the options in the same way as for the convergent lens.

## 8.2 Options

The macro uses the law of Snell

$$\frac{n_1}{n_2} = \frac{\sin \beta}{\sin \alpha} \quad (4)$$

where the  $n_1$  and  $n_2$  are the refraction numbers with the predefined values

$$n_1 = 1 \quad (5)$$

$$n_2 = 1.41 \quad (6)$$

and  $\alpha$  the incoming and  $\beta$  the outgoing angle of the ray.

The refraction numbers have the internal names `refractA` and `refractB`.

## 9 `\mirrorCVG`

The syntax is

```
\mirrorCVG [mirrorType=SPH ]
```

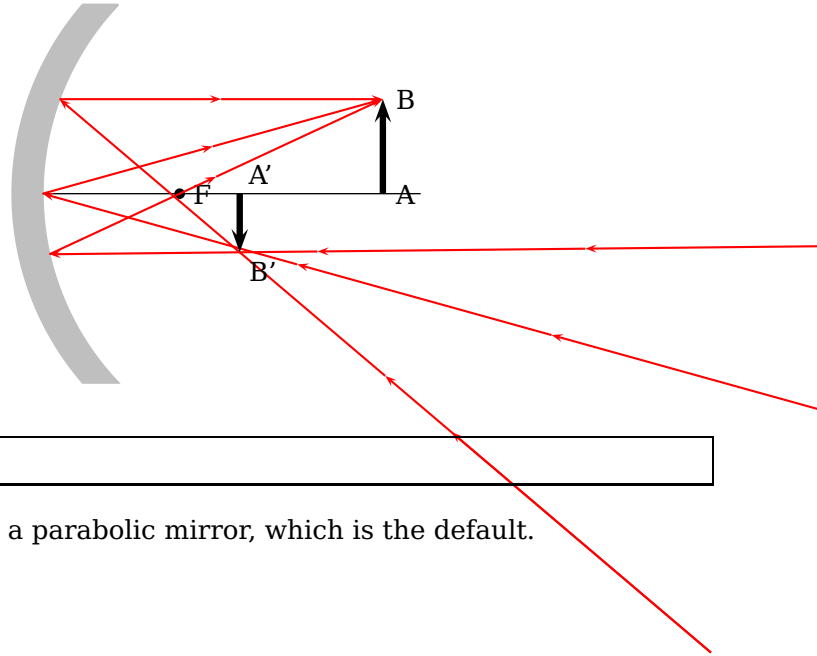

```
\mirrorCVG[mirrorType=SPH]
```

Without the option `mirrorType=SPH` you'll get a parabolic mirror, which is the default.

## 10 `\mirrorDVG`

The syntax is

```
\mirrorDVG [mirrorType=SPH ]
```

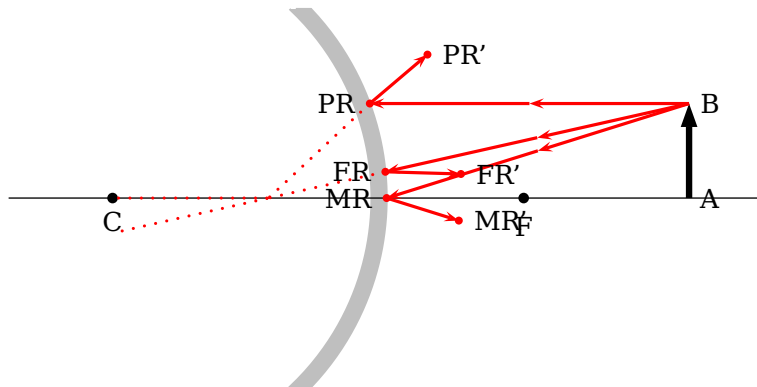

```
\mirrorDVG[mirrorType=SPH]
```

Without the option `mirrorType=SPH` you'll get a parabolic mirror (option `PARA`).

## 11 `\ABinterSPHLens`

The syntax is

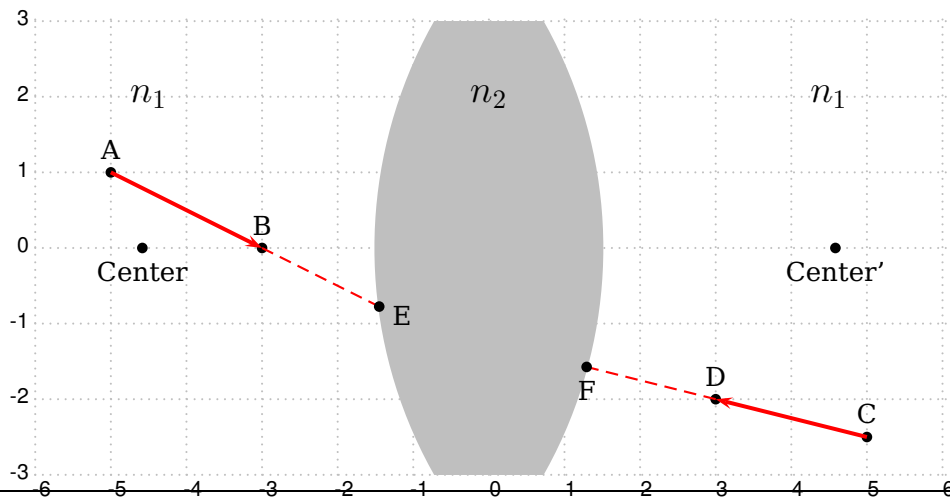

```

\begin{pspicture}[showgrid=true](-6,-3)(6,3)
\lensSPH[lensType=CVG,lensHeight=8,lensWidth=3,drawing=false]
\qdisk(Center){2pt}\uput[-90](Center){Center}
\qdisk(Center'){2pt}\uput[-90](Center'){Center'}
\pnode(-5,1){A}\qdisk(A){2pt}\uput[90](A){A}
\pnode(-3,0){B}\qdisk(B){2pt}\uput[90](B){B}
\psline[linewidth=1.5pt,linecolor=red]{->}(A)(B)
\pnode(5,-2.5){C}\qdisk(C){2pt}\uput[90](C){C}
\pnode(3,-2){D}\qdisk(D){2pt}\uput[90](D){D}
\psline[linewidth=1.5pt,linecolor=red]{->}(C)(D)
\lensSPH[lensType=CVG,lensHeight=8,lensWidth=3,drawing=false]
\ABinterSPHLens(A)(B)(Center'){E}\ABinterSPHLens(C)(D)(Center){F}
\psline[linestyle=dashed,linecolor=red](B)(E)
\psline[linestyle=dashed,linecolor=red](D)(F)
\qdisk(E){2pt}\uput[-20](E){E}\qdisk(F){2pt}\uput[-90](F){F}
\end{pspicture}

```

The macro needs two nodes for the rays, the coordinates/nodes of the center/middle of the spherical lens and a name of the intermediate node. In the figure the macro was called as

```

\ABinterSPHLens(A)(B)(Center'){E}
\ABinterSPHLens(C)(D)(Center){F}

```

## 12 \lensSPHray

The syntax is

```

\lensSPHray [Options] (A)(B){refractA}{refractB}{NodeName}

```

This macro calculates the coordinates of the given ray  $\overline{AB}$  on its way into the lens. The only possible option `rightRay=false|true`<sup>3</sup> enables rays from the right to the left. There are still some problems with this option but try it out.

<sup>3</sup> Default is false

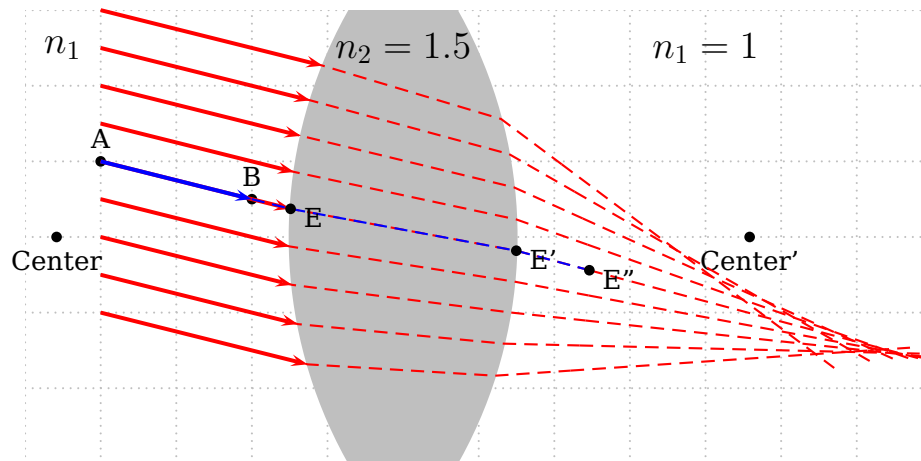

```

\begin{pspicture*}[showgrid=true](-5,-3)(7,3)
\lensSPH[lensType=CVG,lensHeight=8,lensWidth=3,drawing=false]
\qdisk(Center){2pt}\uput[-90](Center){Center}
\qdisk(Center'){2pt}\uput[-90](Center'){Center'}
\pnode(-4,1){A}\qdisk(A){2pt}\uput[90](A){A}
\pnode(-2,0.5){B}\qdisk(B){2pt}\uput[90](B){B}
\lensSPHRay[rayType=ray](-4,1)\lensSPHRay(0,2.5)\lensSPHRay(4,2.5)
\multido{\rA=3+-0.5,\rB=2.5+-0.5}{9}{%
\lensSPHRay[rightRay=false](-4,\rA)(-2,\rB){1}{1.5}{F}
\psline[linewidth=1.5pt,linecolor=red]{->}(-4,\rA)(F)
\psline[linestyle=dashed,linecolor=red](-4,\rA)(F)(F')(F'')
\psOutLine[linestyle=dashed,linecolor=red,length=4.5](F')(F''){FEnd}}
\psline[linewidth=1.5pt,linecolor=blue]{->}(A)(B)
\lensSPHRay[lensType=CVG](A)(B){1}{1.5}{E}
\psline[linestyle=dashed,linecolor=blue](B)(E)(E')(E'')
\qdisk(E){2pt}\uput[-20](E){E}\qdisk(E'){2pt}\uput[-20](E'){E'}
\qdisk(E''){2pt}\uput[-20](E''){E''}
\end{pspicture*}

```

And the same with  $n_2 = 3$ :

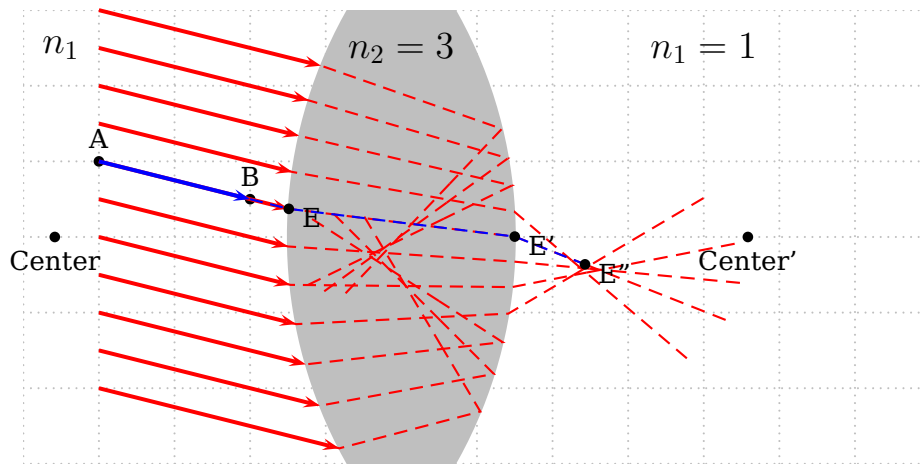

```

\begin{pspicture*}[showgrid=true](-5,-3)(7,3)
\lensSPH[lensType=CVG,lensHeight=8,lensWidth=3,drawing=false]
\qdisk{Center}{2pt}\uput[-90]{Center}{Center}
\qdisk{Center'}{2pt}\uput[-90]{Center'}{Center'}
\pnode(-4,1){A}\qdisk{A}{2pt}\uput[90]{A}{A}
\pnode(-2,0.5){B}\qdisk{B}{2pt}\uput[90]{B}{B}
\rput(-4.5,2.5){\Large $n_1$}\rput(0,2.5){\Large $n_2=3$}\rput(4,2.5){\Large $n_1=1$}
\multido{\rA=3+-0.5,\rB=2.5+-0.5}{11}{%
\lensSPHray[rightRay=false](-4,\rA)(-2,\rB){1}{3}{F}
\psline[linewidth=1.5pt,linecolor=red]{->}(-4,\rA)(F)
\psline[linestyle=dashed,linecolor=red](-4,\rA)(F')(F'')
\psOutLine[linestyle=dashed,linecolor=red](F')(F''){FEnd}}
\psline[linewidth=1.5pt,linecolor=blue]{->}(A)(B)
\lensSPHray[lensType=CVG](A)(B){1}{3}{E}
\psline[linestyle=dashed,linecolor=blue](B)(E)(E')(E'')
\qdisk{E}{2pt}\uput[-20]{E}{E}\qdisk{E'}{2pt}\uput[-20]{E'}{E'}
\qdisk{E''}{2pt}\uput[-20]{E''}{E''}
\end{pspicture*}

```

### 13 \reflectionRay

The syntax is

```
\reflectionRay [Options] (A)(B){NodeName}
```

This macro calculates the coordinates of the given ray  $\overline{AB}$  on its way out of the mirror. The only sensible option is `mirrorType=CVG` or `mirrorType=DVG`. The most important fact is that the point B must be the one on the mirror. If you do not know its coordinates you can use the macro `ABinterSPHLens[lensType=CVG](A1)(A2)(Center){NodeName}`, which calculates the coordinates of the intermediate point.

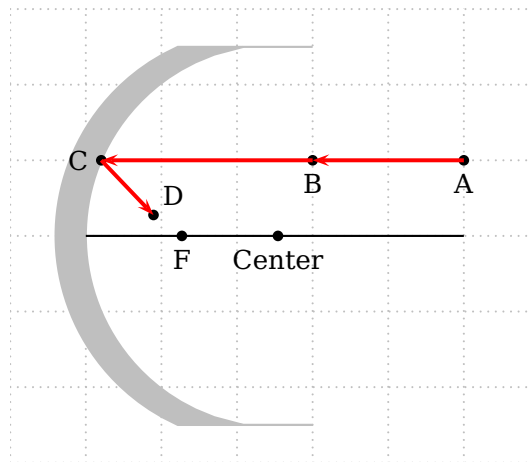

```
\begin{pspicture*}[showgrid=true](-1,-3)(6,3)
\rput(0,0){%
\mirrorCVG[mirrorType=SPH,mirrorHeight=5,mirrorWidth=0.2,yBottom=-3,yTop=3,drawing=false,mirrorDepth=3]
\qdisk(Center){2pt}\qdisk(Focus){2pt}\uput[-90](Center){Center}\uput[-90](Focus){F}
\psline(0)(xRight)}
\ABinterSPHLens(5,1)(3,1)(Center){C}
\reflectionRay[mirrorType=CVG-SPH](5,1)(C){D}
\qdisk(5,1){2pt}\uput[-90](5,1){A}\qdisk(3,1){2pt}\uput[-90](3,1){B}
\qdisk(C){2pt}\uput[180](C){C}\qdisk(D){2pt}\uput[45](D){D}
\psset{linewidth=1.5pt,linecolor=red,arrows=->}
\psline(5,1)(3,1)\psline(3,1)(C)\psline(C)(D)
\end{pspicture*}
```

### 13.1 Refraction at a Spherical surface

Construction for finding the position of the image point  $P'$  of a point object  $P$  formed by refraction at a spherical surface.

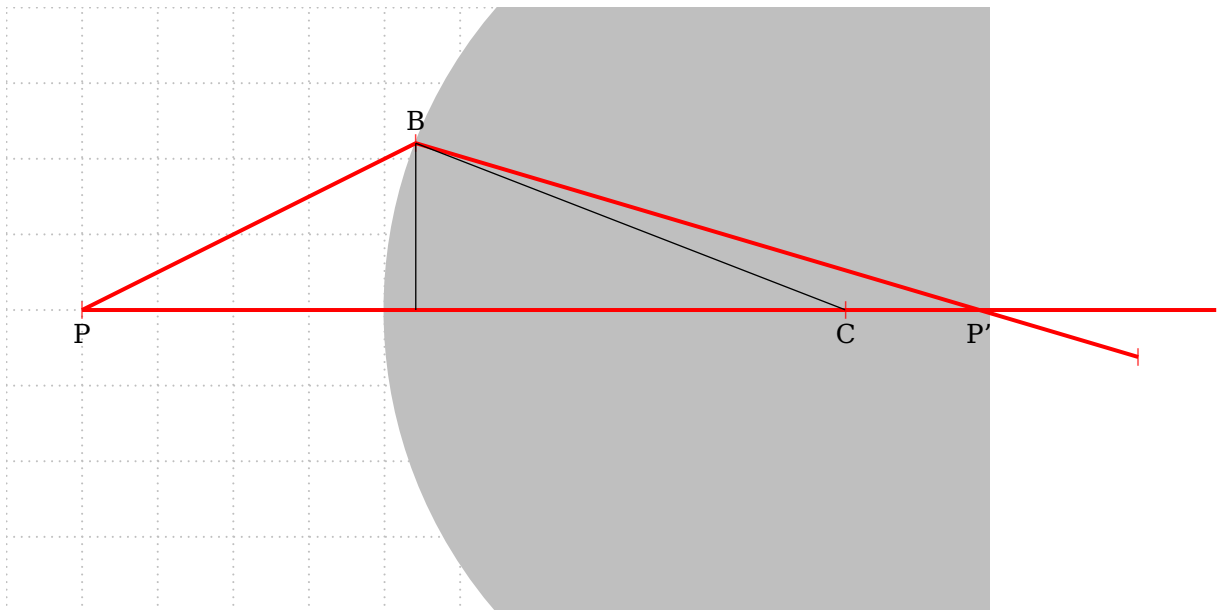

```

\begin{pspicture*}[showgrid=true](-10,-4)(3,4)
\rput(0,0){%
  \lensSPH[lensType=CVG,lensHeight=12,lensWidth=10,yBottom=-6,yTop=6,xLeft=-6,xRight=6,drawing=false]}
\psset{linecolor=red,linewidth=1.5pt,dotstyle=}
\node(-9,0){P}\psdots(P)\uput[-90](P){P}\psline(P)(xRight)
\lensSPHray(P)(-5,2){1}{9}{Q}\psline(P)(Q)(Q')\psdots(Q)\uput[90](Q){B}
\ABinterCD(Q)(Q')(0,0)(5,0){P'}\psdots(Q')\uput[-90](P'){P'}
\psline[linewidth=0.5pt,linecolor=black](Center')(Q)\psline[linewidth=0.5pt,linecolor=black](Q)(Q|0,0)
\psdots(Center')\uput[-90](Center'){C}
\end{pspicture*}

```



Construction for determining the height of an image formed by refraction at a spherical surface.

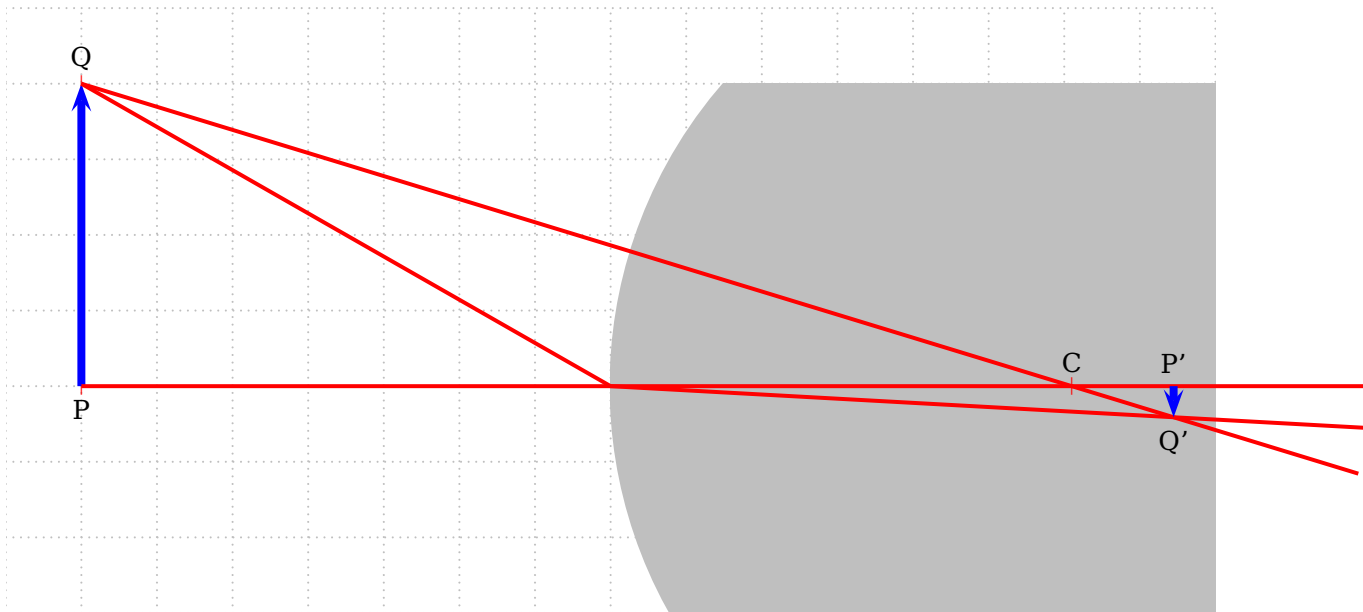

```
\begin{pspicture*}[showgrid=true](-13,-3)(3,5)
\rput(0,0){%
  \lensSPH[lensType=CVG,lensHeight=12,lensWidth=10,yBottom=-4,yTop=4,xLeft=-5,xRight=5,drawing=false]}
\psset{linecolor=red,linewidth=1.5pt,dotstyle=}
\pnode(-12,0){P}\psdots(P)\uput[-90](P){P}\pnode(-12,4){Q}\psdots(Q)\uput[90](Q){Q}
\psline[linecolor=blue,linewidth=3pt,arrows=->](P)(Q)\psline(P)(xRight)
\lensSPHRay(Q)(Center'){1}{9}{S1}\lensSPHRay(Q)(-5,0){1}{9}{S2}%
\psline(Q)(S1')\psline(Q)(S2)(S2')\ABinterCD(Q)(S1')(S2)(S2'){Q'}\pnode(Q'|0,0){P'}
\psline[linecolor=blue,linewidth=3pt,arrows=->](P')(Q')
\uput[90](P'){P'}\uput[-90](Q'){Q'}\psdots(Center')\uput[90](Center'){C}
\end{pspicture*}
```

## 14 Utility Macros

### 14.1 \eye

Syntax:

```
\eye
```

There are no Options for this symbol of an human eye. Use the \rput-macro to put the eye elsewhere.

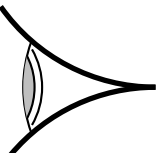

```
\begin{pspicture}(-1,-0.75)(1,0.75)
\rput(1,0){\eye}
\end{pspicture}
```

## 15 \Arrows

Syntax with the following options:

`\Arrows [Options] (NodeA)(NodeB)`

Option	Name	Standard
Offset for arrow start in cm	posStart	0
Length of the arrow in cm	length	2

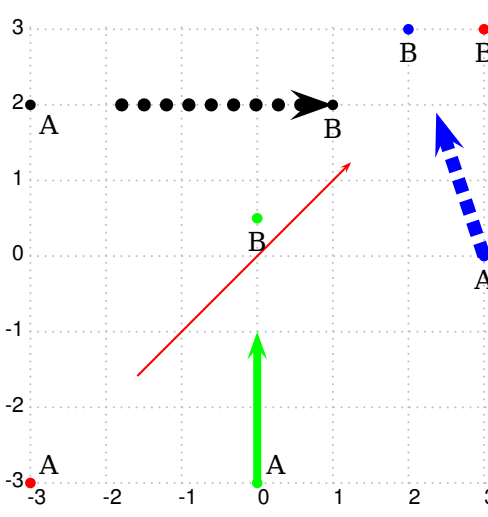

```

\begin{pspicture}[showgrid=true](-3,-3)(3,3)
\psset{linecolor=red}
\Arrows[posStart=2,length=4](-3,-3)(3,3)
\qdisk(-3,-3){2pt}\uput[45](-3,-3){A}
\qdisk(3,3){2pt}\uput[-90](3,3){B}
\psset{linecolor=green}
\Arrows[linewidth=3pt,length=2](0,-3)(0,0.5)
\qdisk(0,-3){2pt}\uput[45](0,-3){A}
\qdisk(0,0.5){2pt}\uput[-90](0,0.5){B}
\psset{linecolor=blue}
\Arrows[linewidth=5pt,linestyle=dashed](3,0)(2,3)
\qdisk(3,0){2pt}\uput[-90](3,0){A}
\qdisk(2,3){2pt}\uput[-90](2,3){B}
\psset{linecolor=black}
\Arrows[posStart=1,linewidth=5pt,linestyle=dotted,
length=3](-3,2)(1,2)
\qdisk(-3,2){2pt}\uput[-45](-3,2){A}
\qdisk(1,2){2pt}\uput[-90](1,2){B}
\end{pspicture}
    
```

### 16 \psOutLine and \psBeforeLine

Syntax:

`\psOutLine [Options] (NodeA)(NodeB){EndNode}`  
`\psBeforeLine [Options] (NodeA)(NodeB){StartNode}`

The only special option is `length=<value>`. All other which are possible for `\psline` can be used, too.

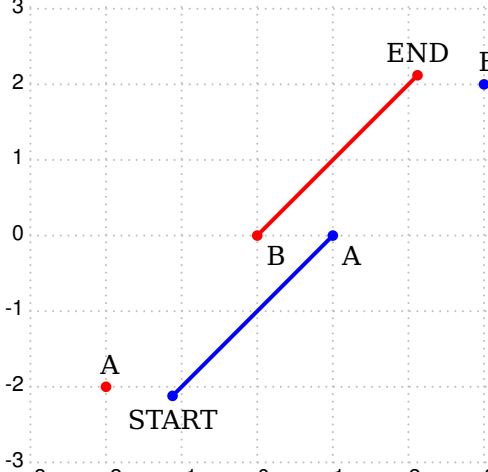

```

\begin{pspicture}[showgrid=true](-3,-3)(3,3)
\psset{linecolor=red,linewidth=1.5pt}
\psOutLine[length=3](-2,-2)(0,0){End}
\qdisk(-2,-2){2pt}\uput[80](-2,-2){A}
\qdisk(0,0){2pt}\uput[-45](0,0){B}
\qdisk(2.12,2.12){2pt}\uput[90](2.12,2.12){END}
%
\psset{linecolor=blue}
\psBeforeLine[length=3](1,0)(3,2){START}
\qdisk(3,2){2pt}\uput[80](3,2){B}
\qdisk(1,0){2pt}\uput[-45](1,0){A}
\qdisk(-1.12,-2.12){2pt}\uput[-90](-1.12,-2.12){START}
\end{pspicture}
    
```

### 17 \Parallel

Syntax:

```
\Parallel [Options] (NodeA) (NodeB) (StartNode) {End node}
```

The only special option for `\Parallel` is `length=<value>`. The nodes `nodeA` and `nodeB` are known nodes of a given line and `Start node` is the given node of a parallel line. `End node` is the name of the calculated line end.

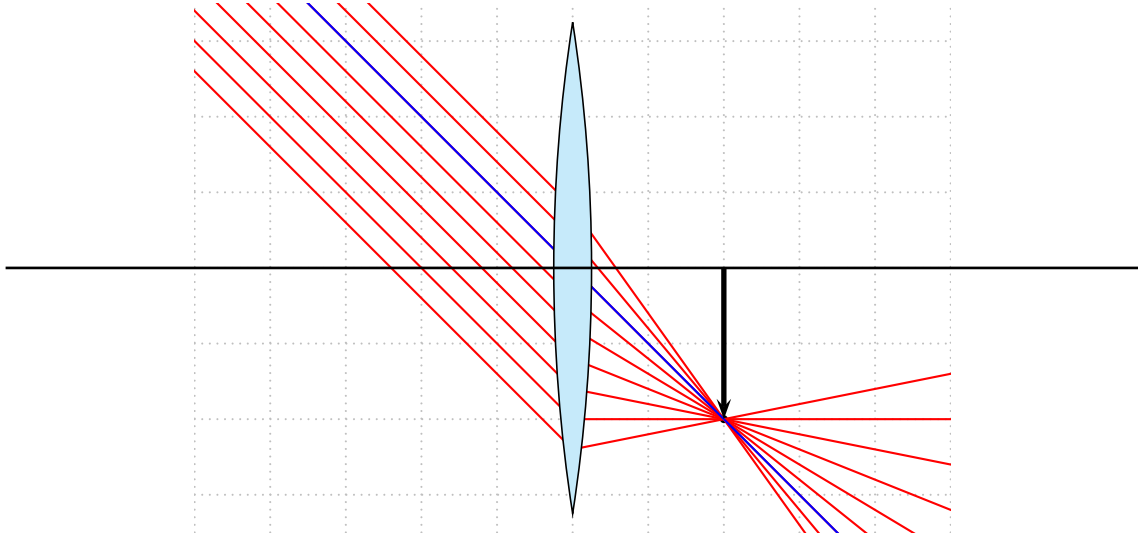

```
\begin{pspicture*}[showgrid=true](-5,-3.5)(5,3.5)
\pnode(2,-2){FF}\qdisk(FF){1.5pt}\pnode(-5,5){A}\pnode(0,0){O}
\multido{\nCountA=-2.4+0.4}{9}{%
\Parallel[linecolor=red,length=9](O)(A)(0,\nCountA){P1}
\psline[linecolor=red](0,\nCountA)(FF)
\psOutLine[linecolor=red,length=9](0,\nCountA)(FF){P2}}
\psline[linecolor=blue](A)(FF)
\psOutLine[linecolor=blue,length=5](A)(FF){END1}
\rput(0,0){\lens[yBottom=-3.5,yTop=3.5,lensGlass,lensHeight=6.5,drawing=false,
spotFi=315,lensWidth=0.5]
\psline[linewidth=1pt](xLeft)(xRight)
\psline[length=2,linewidth=2pt,arrows=->](F')(FF)}
\end{pspicture*}
```

## 18 \ABinterCD and \nodeBetween

This macro is used by the `\telescope` macro. It determines the intersection point of two lines, in this case a ray and the mirror axis. The following figure shows a part of figure 10. Given are the points `A`, `B` (focus), `C/D` (mirror axis). We need the point `E` to draw the other rays for the ocular, which can be done with the `\ABinterCD` macro. The syntax is:

```
\ABinterCD(A)(B)(C)(D){E}
\nodeBetween(A)(B){C}
```

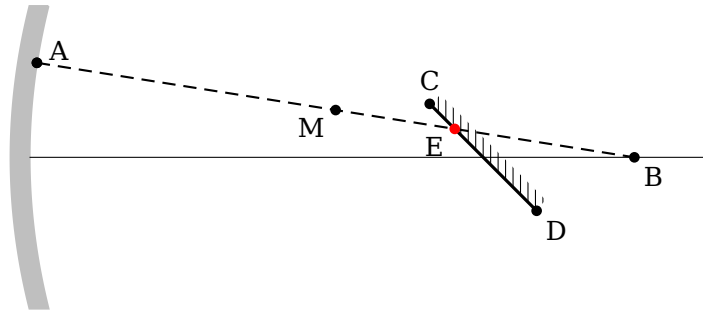

```
\begin{pspicture*}(-0.5,-2.25)(9,2.25)
\rrput(0,0){\mirrorCVG[mirrorHeight=4,mirrorWidth=0.25,mirrorDepth=0.25,drawing=false]}
\mirrorCVGRay[mirrorHeight=4,mirrorWidth=0.25,mirrorDepth=0.25,drawing=false](8,1.25)(2,1.25){A}
\psline[linewidth=0.5\pslinewidth](9,0)
\rrput{-45}(6,0){\mirrorTwo}
\qdisk(A){2pt}\uput[30](A){A}\pnode(8,0){B}\qdisk(B){2pt}\uput[-45](B){B}
\pnode(! 6 1 45 cos mul sub 1 45 sin mul){C}
\qdisk(C){2pt}\uput[90](C){C}\pnode(! 6 1 45 cos mul add 1 45 sin mul neg){D}
\uput[-45](D){D}\qdisk(D){2pt}\psline[linestyle=dashed](A)(B)
\ABinterCD(A)(B)(C)(D){Inter1}\qdisk(A){2pt}
\nodeBetween(A)(B){M}\qdisk(M){2pt}
{\psset{linecolor=red}
\qdisk(Inter1){2pt}\uput[220](Inter1){E}\uput[220](M){M}}
\end{pspicture*}
```

**19 \rotateNode**

The syntax is

```
\rotateNode{NodeName}{Degrees}
```

The coordinates of the node A are changed to the new ones. Negative values are possible for rotating clockwise.

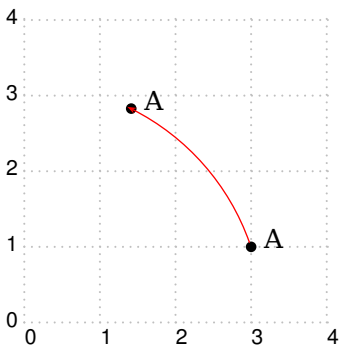

```
\begin{pspicture}[showgrid=true](4,4)
\pnode(3,1){A}\qdisk(A){2pt}\uput[20](A){A}
\rotateNode(A){45}
\qdisk(A){2pt}\uput[20](A){A}
\psarc[linecolor=red,
linewidth=0.5pt]{->}(0,0){3.16}{19.47}{64.47}
\end{pspicture}
```

**20 \rotateTriangle**

The syntax is

```
\rotateNode{NodeNameA}{NodeNameB}{NodeNameC}{Degrees}
```

The coordinates of the nodes A,B,C are changed to the new ones. Negative values are possible for rotating clockwise.

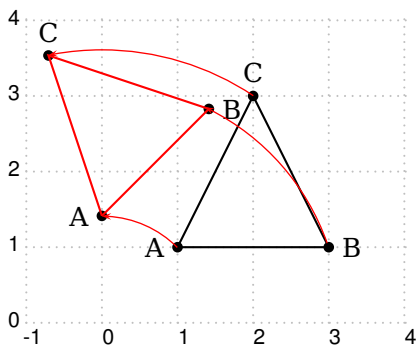

```
\begin{pspicture}[showgrid=true](-1,0)(4,4)
\node(1,1){A}\node(3,1){B}\node(2,3){C}
\qdisk(A){2pt}\uput[180](A){A}\qdisk(B){2pt}\uput[0](B){B}
\qdisk(C){2pt}\uput[90](C){C}
\psline(A)(B)(C)(A)\rotateTriangle(A)(B)(C){45}
\qdisk(A){2pt}\uput[180](A){A}\qdisk(B){2pt}\uput[0](B){B}
\qdisk(C){2pt}\uput[90](C){C}\psline[linecolor=red](A)(B)(C)(A)
\psarc[linecolor=red,linewidth=0.5pt]{->}(0,0){3.16}{19.47}{64.47}
\psarc[linecolor=red,linewidth=0.5pt]{->}(0,0){1.41}{45}{90}
\psarc[linecolor=red,linewidth=0.5pt]{->}(0,0){3.61}{56.31}{101.31}
\end{pspicture}
```

## 21 \rotateFrame

The syntax is

```
\rotateFrame{NodeNameA}{NodeNameB}{NodeNameC}{NodeNameD}{Degrees}
```

The coordinates of the nodes A,B,C,D are changed to the new ones. Negative values are possible for rotating clockwise.

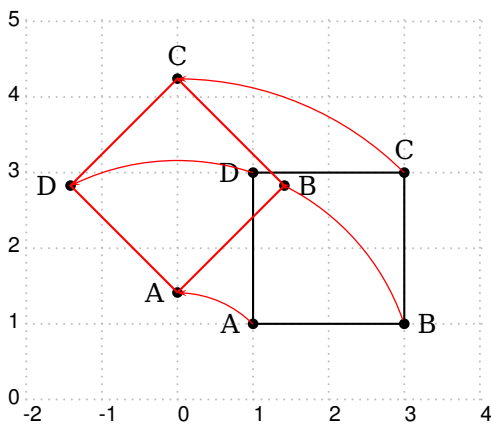

```
\begin{pspicture}[showgrid=true](-2,0)(4,5)
\node(1,1){A}\node(3,1){B}\node(3,3){C}\node(1,3){D}
\qdisk(A){2pt}\uput[180](A){A}\qdisk(B){2pt}\uput[0](B){B}
\qdisk(C){2pt}\uput[90](C){C}\qdisk(D){2pt}\uput[180](D){D}
\psline(A)(B)(C)(D)(A)
\rotateFrame(A)(B)(C)(D){45}
\qdisk(A){2pt}\uput[180](A){A}\qdisk(B){2pt}\uput[0](B){B}
\qdisk(C){2pt}\uput[90](C){C}\qdisk(D){2pt}\uput[180](D){D}
\psline[linecolor=red](A)(B)(C)(D)(A)
\psarc[linecolor=red,linewidth=0.5pt]{->}(0,0)
{3.16}{19.47}{64.47}
\psarc[linecolor=red,linewidth=0.5pt]{->}(0,0){1.41}{45}{90}
\psarc[linecolor=red,linewidth=0.5pt]{->}(0,0){4.24}{45}{90}
\psarc[linecolor=red,linewidth=0.5pt]{->}(0,0)
{3.16}{71.57}{116.57}
\end{pspicture}
```

## 22 \arrowLine

The syntax is

```
\arrowLine [Options] (Start) (End) {ArrowNumber}
```

Draws a line from Start to End with ArrowNumber arrows inside.

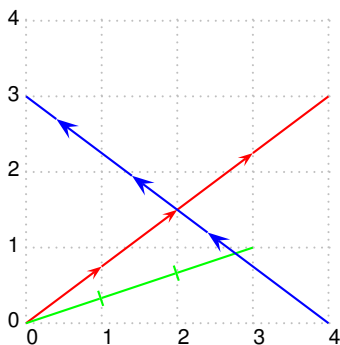

```
\begin{pspicture}[showgrid=true](4,4)
\arrowLine[linecolor=red](0,0)(4,3){3}
\arrowLine[linecolor=green,arrowsize=6pt,arrows=-](0,0)(3,1){2}
\arrowLine[linecolor=blue,arrowOffset=0.75,arrowsize=6pt](4,0)(0,3){3}
\end{pspicture}
```

## 22.1 Options

A special option is `arrowOffset`, which makes it possible to draw lines with different arrows. By default the arrows are placed symmetrically. This can be moved by `arrowOffset`. Additionally all other valid options for `pslines` are possible here, too.

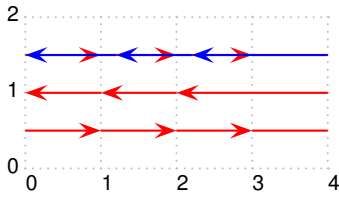

```
\begin{pspicture}[showgrid=true](4,2)
\arrowLine[arrowsize=6pt,linecolor=red](0,0.5)(4,0.5){3}
\arrowLine[arrowsize=6pt,linecolor=red,
arrows=<-](0,1)(4,1){3}
\arrowLine[arrowsize=6pt,linecolor=red](0,1.5)(4,1.5){3}
\arrowLine[arrowsize=6pt,linecolor=blue,arrows=<- ,
arrowOffset=0.2](0,1.5)(4,1.5){3}
\end{pspicture}
```

## 23 List of all optional arguments for pst-optic

Key	Type	Default
lensTwo	boolean	false
lensGlass	boolean	true
onlyrays	boolean	true
drawing	boolean	true
rightRay	boolean	false
xLeft	ordinary	-7.5
xRight	ordinary	7.5
yBottom	ordinary	-3.0
yTop	ordinary	3.0
lensType	ordinary	CVG
lensColor	ordinary	lightgray
lensWidth	ordinary	0.5
lensDepth	ordinary	1
lensHeight	ordinary	5
lensScale	ordinary	1
lensArrowSize	ordinary	0.2
lensArrowInset	ordinary	0.5
mirrorType	ordinary	CVG
mirrorDepth	ordinary	1
mirrorHeight	ordinary	5
mirrorWidth	ordinary	0.25
mirrorColor	ordinary	lightgray
mirrorFocus	ordinary	8
posMirrorTwo	ordinary	6
mirrorTwoAngle	ordinary	45
refractA	ordinary	1
refractB	ordinary	1.41
X0	ordinary	0
Y0	ordinary	0
posStart	ordinary	0
length	ordinary	2
focus	ordinary	2
AB	ordinary	1
OA	ordinary	-3
arrowOffset	ordinary	0
nameA	ordinary	A
spotA	ordinary	270
nameB	ordinary	B
spotB	ordinary	90
nameF	ordinary	F
spotF	ordinary	270
nameO	ordinary	0
spotO	ordinary	225
nameAi	ordinary	A'

*Continued on next page*

*Continued from previous page*

Key	Type	Default
spotAi	ordinary	90
nameBi	ordinary	B'
spotBi	ordinary	270
nameFi	ordinary	F'
spotFi	ordinary	270
rayColor	ordinary	red
parallelrayColor	ordinary	red
focalrayColor	ordinary	red
centerrayColor	ordinary	red
rayWidth	ordinary	1.5\pslinewidth
AnglePrism	ordinary	[none]
AnglePlan1	ordinary	[none]
AnglePlan2	ordinary	[none]
lambda	ordinary	[none]
k	ordinary	[none]
notations	boolean	true

## References

- [1] Victor Eijkhout. *T<sub>E</sub>X by Topic – A T<sub>E</sub>Xnician Reference*. 1st ed. Heidelberg/Berlin: DANTE – lehmanns media, 2014.
- [2] Denis Girou. “Présentation de PSTricks”. In: *Cahier GUTenberg* 16 (Apr. 1994), pp. 21–70.
- [3] Denis Girou and Manuel Luque. *PSTlens - PostScript macros for Generic TeX*. 2001. URL: </graphics/pstricks/contrib/pst-lens/>.
- [4] Michel Goossens et al. *The L<sup>A</sup>T<sub>E</sub>X Graphics Companion. Reprint of the 2nd edition*. 2nd ed. Heidelberg and Berlin: Lehmanns Media, 2023.
- [5] Nikolai G. Kollock. *PostScript richtig eingesetzt: vom Konzept zum praktischen Einsatz*. Vaterstetten: IWT, 1989.
- [6] Herbert Voß. “Die mathematischen Funktionen von Postscript”. In: *Die T<sub>E</sub>Xnische Komödie* 1/02 (Mar. 2002), pp. 40–47.
- [7] Herbert Voß. *Presentations with L<sup>A</sup>T<sub>E</sub>X*. 1st ed. Heidelberg/Berlin: DANTE – Lehmanns Media, 2012.
- [8] Herbert Voß. *PSTricks – Grafik für T<sub>E</sub>X und L<sup>A</sup>T<sub>E</sub>X*. 7th ed. Heidelberg/Hamburg: DANTE – Lehmanns, 2016.
- [9] Herbert Voß. *PSTricks – Graphics and PostScript for L<sup>A</sup>T<sub>E</sub>X*. 1st ed. Cambridge – UK: UIT, 2011.
- [10] Herbert Voß. *L<sup>A</sup>T<sub>E</sub>X quick reference*. 1st ed. Cambridge – UK: UIT, 2012.
- [11] Timothy Van Zandt. *multido.tex - a loop macro, that supports fixed-point addition*. 1997. URL: </macros/generic/multido.tex>.
- [12] Timothy Van Zandt and Denis Girou. “Inside PSTricks”. In: *TUGboat* 15 (Sept. 1994), pp. 239–246.



## Index

AB, 8  
\ABinterCD, 34  
alpha2, 22  
AnglePlan1, 20  
AnglePlan2, 20  
AnglePrism, 20, 22  
\arrowLine, 36  
arrowOffset, 37  
\Arrows, 33  
  
B'1, 11  
B1, 11  
\beamLight, 18  
  
centerrayColor, 5  
CVG, 8, 24, 30  
  
drawing, 12  
DVG, 8, 24, 30  
  
Environment  
    pspicture, 3, 8, 18  
\eye, 32  
  
F'1, 11  
factice, 9  
false, 8  
focalrayColor, 5  
focus, 8  
  
I11, 11  
  
k, 20, 23  
Keyvalue  
    CVG, 8  
    DVG, 8  
    lensType, 5  
    PCVG, 8  
    PDVG, 8  
Keyword  
    AB, 8  
    alpha2, 22  
    AnglePlan1, 20  
    AnglePlan2, 20  
    AnglePrism, 20, 22  
    arrowOffset, 37  
    centerrayColor, 5  
    drawing, 12  
    focalrayColor, 5  
    focus, 8  
    k, 20, 23  
    lambda, 20  
    length, 33, 34  
    lensArrowInset, 8  
    lensArrowSize, 8  
    lenscolor, 8  
    lensGlass, 8  
    lensHeight, 5, 8, 24  
    lensScale, 5, 8  
    lensTwo, 8, 9  
    lensType, 8, 24  
    lensWidth, 5, 8, 24  
    mirrorColor, 12  
    mirrorDepth, 12  
    mirrorFocus, 12  
    mirrorHeight, 12  
    mirrorTwoAngle, 12  
    mirrorType, 26, 30  
    mirrorWidth, 12  
    nameA, 3  
    nameAi, 3  
    nameB, 3  
    nameBi, 3  
    nameF, 3  
    nameFi, 3  
    nameO, 3  
    nodesep, 19  
    notations, 20  
    OA, 8, 24  
    onlyrays, 8  
    parallelrayColor, 5  
    posMirrorTwo, 12  
    posStart, 33  
    rayColor, 3, 12  
    raycolor, 5  
    refractB, 24  
    rightRay, 27  
    spotA, 3  
    spotAi, 3  
    spotB, 3  
    spotBi, 3  
    spotF, 3  
    spotFi, 3

- spot0, 3
- xBottom, 3, 12
- xLeft, 3, 12
- X0, 3
- xRight, 3, 12
- xTop, 3, 12
- Y0, 3
  
- lambda, 20
- length, 33, 34
- \lens, 5, 8, 11
- lensArrowInset, 8
- lensArrowSize, 8
- lenscolor, 8
- \lensCVG, 5
- \lensDVG, 5
- lensGlass, 8
- lensHeight, 5, 8, 24
- lensScale, 5, 8
- \lensSPH, 24
- \lensSPHray, 27
- lensTwo, 8, 9
- lensType, 5, 8, 24
- lensWidth, 5, 8, 24
  
- Macro
  - \ABinterCD, 34
  - \arrowLine, 36
  - \Arrows, 33
  - \beamLight, 18
  - \eye, 32
  - \lens, 5, 8, 11
  - \lensCVG, 5
  - \lensDVG, 5
  - \lensSPH, 24
  - \lensSPHray, 27
  - \mirrorCVG, 13, 26
  - \mirrorCVGRay, 16
  - \mirrorDVG, 26
  - \mirrorDVGRay, 16
  - \newsstyle, 4
  - \nodeBetween, 34
  - \Parallel, 11, 34
  - \planMirrorRay, 16
  - \psBeforeLine, 33
  - \pslensCVG, 5
  - \pslensDVG, 5
  - \psline, 33
  - \psOutLine, 33
  - \psset, 5
  - \pst-optic, 3
  - \psttextpath, 16
  - \rayInterLense, 11
  - \reflectionRay, 30
  - \refractionRay, 19
  - \resetOpticOptions, 4
  - \rotateFrame, 36
  - \rotateNode, 35
  - \rput, 3, 8, 18, 32
  - \symPlan, 16
  - \telescop, 11, 34
  - \Transform, 9
- mirrorColor, 12
- \mirrorCVG, 13, 26
- \mirrorCVGRay, 16
- mirrorDepth, 12
- \mirrorDVG, 26
- \mirrorDVGRay, 16
- mirrorFocus, 12
- mirrorHeight, 12
- MirrorNode, 16
- MirrorNode', 16
- MirrorNode", 16
- mirrorTwoAngle, 12
- mirrorType, 26, 30
- mirrorWidth, 12
- multido, 2
  
- nameA, 3
- nameAi, 3
- nameB, 3
- nameBi, 3
- nameF, 3
- nameFi, 3
- nameO, 3
- \newsstyle, 4
- \nodeBetween, 34
- nodesep, 19
- notations, 20
  
- OA, 8, 24
- onlyrays, 8
- opticalAxis, 4
  
- Package
  - multido, 2
  - pst-3d, 2
  - pst-grad, 2

- pst-math, 2
- pst-node, 2
- pst-optic, 2, 4
- pst-plot, 2
- pst-text, 16
- pst-xke, 2
- pstricks, 2, 3
- \Parallel, 11, 34
- parallelrayColor, 5
- PCVG, 8
- PDVG, 8
- \planMirrorRay, 16
- posMirrorTwo, 12
- posStart, 33
- \psBeforeLine, 33
- \pslensCVG, 5
- \pslensDVG, 5
- \psline, 33
- \psOutLine, 33
- pspicture, 3, 8, 18
- \psset, 5
- pst-3d, 2
- pst-grad, 2
- pst-math, 2
- pst-node, 2
- \pst-optic, 3
- pst-optic, 2, 4
- pst-plot, 2
- pst-text, 16
- pst-xke, 2
- \pstextpath, 16
- pstricks, 2, 3
- rayColor, 3, 12
- raycolor, 5
- \rayInterLense, 11
- \reflectionRay, 30
- refractA, 25
- refractB, 24, 25
- \refractionRay, 19
- \resetOpticOptions, 4
- rightRay, 27
- \rotateFrame, 36
- \rotateNode, 35
- \rput, 3, 8, 18, 32
- SPH, 26
- spotA, 3
- spotAi, 3
- spotB, 3
- spotBi, 3
- spotF, 3
- spotFi, 3
- spotO, 3
- \symPlan, 16
- Syntax
  - B'1, 11
  - B1, 11
  - F'1, 11
  - I11, 11
  - MirrorNode, 16
  - MirrorNode', 16
  - MirrorNode", 16
  - opticalAxis, 4
  - refractA, 25
  - refractB, 25
- \telescop, 11, 34
- \Transform, 9
- true, 8, 9
- Value
  - CVG, 24, 30
  - DVG, 24, 30
  - false, 8
  - SPH, 26
  - true, 8, 9
- xBottom, 3, 12
- xLeft, 3, 12
- X0, 3
- xRight, 3, 12
- xTop, 3, 12
- Y0, 3